

Miniature Glass Passivated Single-Phase Bridge Rectifiers
Reverse Voltage 50 to 1000 Volts Forward Current 1.0 Ampere

Features

- ◆ Ideal for printed circuit boards
- ◆ Applicable for automotive insertion
- ◆ High surge current capability
- ◆ Solder Dip 260 °C, 40 seconds

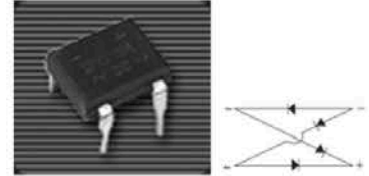

DF

Mechanical Data

- ◆ Case: DF
Epoxy meets UL-94V-0 Flammability rating
- ◆ Terminals: Matte tin plated (E3 Suffix) leads, solderable per J-STD-002B and JESD22-B102D
- ◆ Polarity: As marked on body

Typical Applications

General purpose use in ac-to-dc bridge full wave rectification for SMPS, Lighting Ballaster, Adapter, Battery Charger, Home Appliances, Office Equipment, and Telecommunication applications

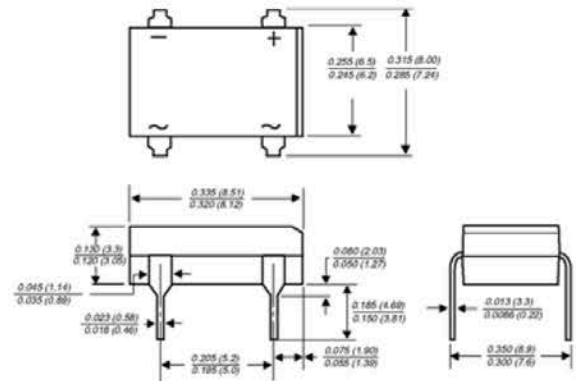

Maximum Ratings and Electrical Characteristics

(Ratings at 25°C ambient temperature unless otherwise specified.)

Parameter	Symbols	DF005M	DF01M	DF02M	DF04M	DF06M	DF08M	DF10M	Units
Maximum repetitive peak reverse voltage	V_{RRM}	50	100	200	400	600	800	1000	Volts
Maximum RMS voltage	V_{RMS}	35	70	140	280	420	560	700	Volts
Maximum DC blocking voltage	V_{DC}	50	100	200	400	600	800	1000	Volts
Maximum average forward output rectified current at $T_A=40^\circ\text{C}$	$I_{F(AV)}$	1.0							Amp
Peak forward surge current single half sine-wave superimposed on rated load (JEDEC Method)	I_{FSM}	30.0							Amps
Rating for fusing ($t < 8.3\text{ms}$)	I^2t	10							A^2sec
Maximum instantaneous forward voltage drop per leg at 0.5A	V_F	1.1							Volts
Maximum DC reverse current at rated DC blocking voltage per leg	I_R	5.0 500							μA
Typical junction capacitance per leg at 4.0V, 1MHz	C_J	25							pF
Typical thermal resistance per leg (Note 1)	$R_{\theta JA}$ $R_{\theta JL}$	40 15							$^\circ\text{C/W}$
Operating junction and storage temperature range	T_J, T_{STG}	-55 to +150							$^\circ\text{C}$

Notes: 1. Thermal resistance from junction to ambient and from junction to lead mounted on P.C.B. with 0.5 x 0.5" (13 x 13mm) copper pads

($T_A = 25^\circ\text{C}$ unless otherwise noted)

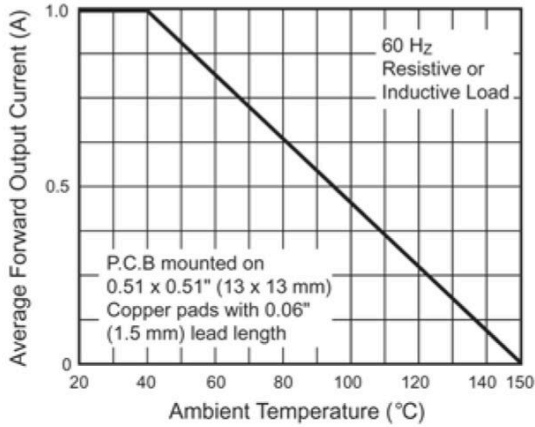

Figure 1. Derating Curve Output Rectified Current

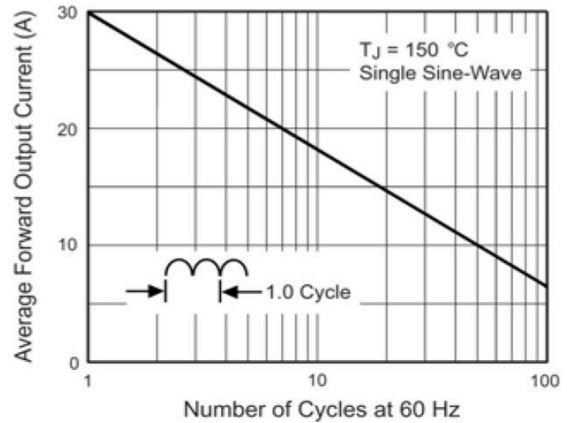

Figure 2. Maximum Non-Repetitive Peak Forward Surge Current Per Leg

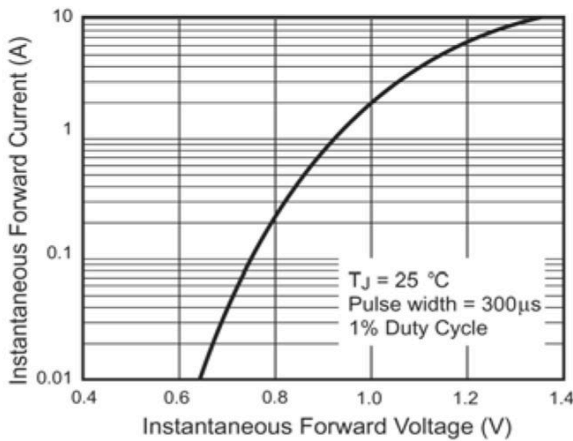

Figure 3. Typical Forward Characteristics Per Leg

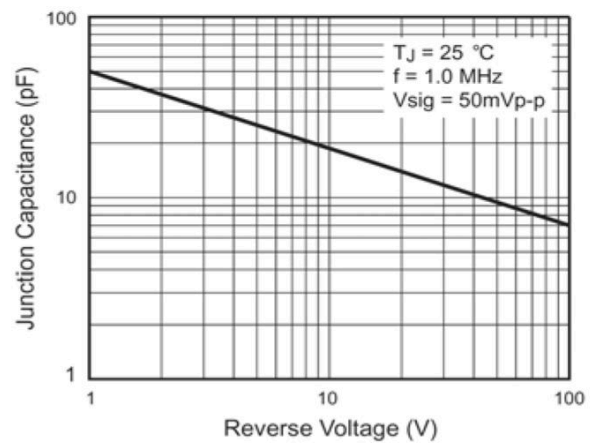

Figure 5. Typical Junction Capacitance Per Leg

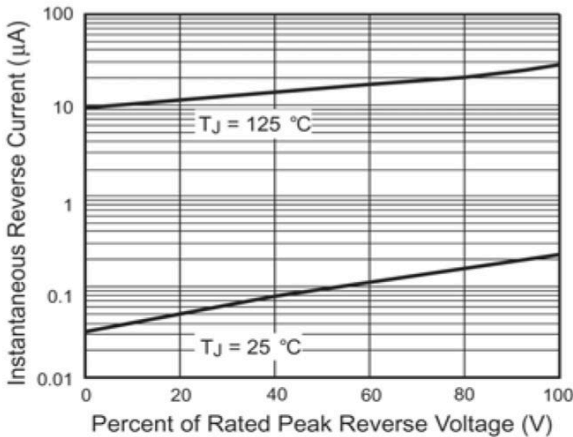

Figure 4. Typical Reverse Leakage Characteristics Per Leg

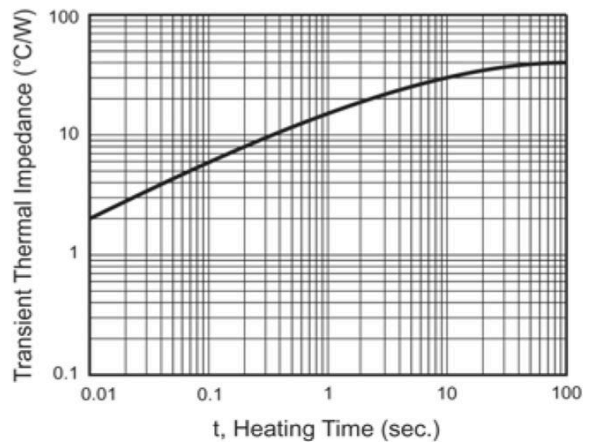

Figure 6. Typical Transient Thermal Impedance