

Miniature Glass Passivated Single-Phase Bridge Rectifiers
Reverse Voltage 200 to 1000 Volts Forward Current 0.5 Ampere

Features

- ◆ Plastic package has Underwriters Laboratory Flammability Classification 94V-0
- ◆ Glass passivated chip junctions
- ◆ High surge overload rating: 35A peak
- ◆ Saves space on printed circuit boards
- ◆ Recommended for non-automotive applications

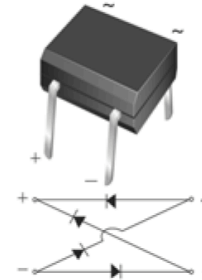

MBM

Mechanical Data

- ◆ Case: Molded plastic body over passivated junctions
- ◆ Terminals: Plated leads solderable per MIL-STD-750, Method 2026
- ◆ Mounting Position: Any
- ◆ Weight: 0.078 oz., 0.22 g

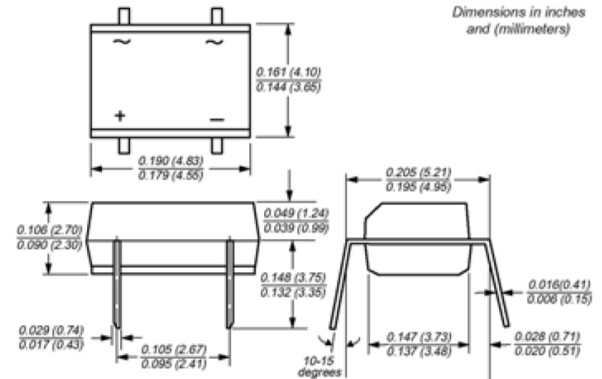

Maximum Ratings and Electrical Characteristics

($T_A=25^\circ\text{C}$ unless otherwise noted)

Parameter	Symbols	MB2M	MB4M	MB6M	MB8M	MB10M	Units
Maximum repetitive peak reverse voltage	V_{RRM}	200	400	600	800	1000	Volts
Maximum RMS voltage	V_{RMS}	140	280	420	560	700	Volts
Maximum DC blocking voltage	V_{DC}	200	400	600	800	1000	Volts
Maximum average forward output rectified current (see Fig.1) on glass-epoxy P.C.B. on aluminum substrate	$I_{F(AV)}$	0.5 ⁽¹⁾ 0.8 ⁽²⁾					Amp
Peak forward surge current 8.3 ms single half sine-wave superimposed on rated load (JEDEC Method)	I_{FSM}	35.0					Amps
Rating for fusing ($t < 8.3\text{ms}$)	I^2t	5.0					A^2sec
Maximum instantaneous forward voltage drop per leg at 0.4A	V_F	1.0					Volt
Maximum DC reverse current at rated DC blocking voltage per leg	I_R	5.0 100					μA
Typical thermal resistance per leg	$R_{\theta JA}$ $R_{\theta JA}$ $R_{\theta JL}$	85 ⁽¹⁾ 70 ⁽²⁾ 20 ⁽¹⁾					$^\circ\text{C/W}$
Typical junction capacitance per leg ⁽³⁾	C_J	13					pF
Operating junction and storage temperature range	T_J, T_{STG}	-55 to +150					$^\circ\text{C}$

- Notes:**
1. On glass epoxy P.C.B. mounted on 0.05 x 0.05" (1.3 x 1.3mm) pads
 2. On aluminum substrate P.C.B. with an area of 0.8" x 0.8" (20 x 20mm) mounted on 0.05 x 0.05" (1.3 x 1.3mm) solder pad
 3. Measured at 1.0 MHz and applied reverse voltage of 4.0 Volts

RATINGS AND CHARACTERISTIC CURVES

($T_A = 25^\circ\text{C}$ unless otherwise noted)

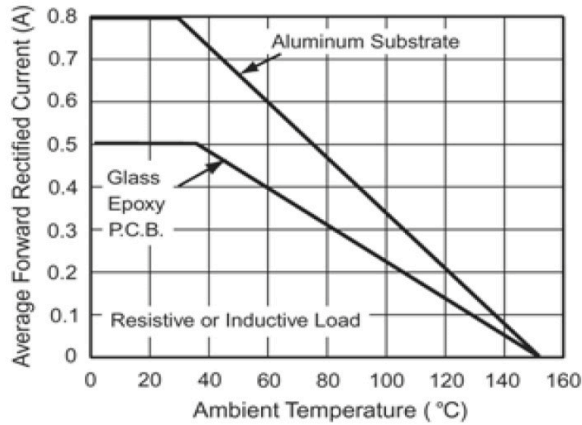

Figure 1. Derating Curve for Output Rectified Current

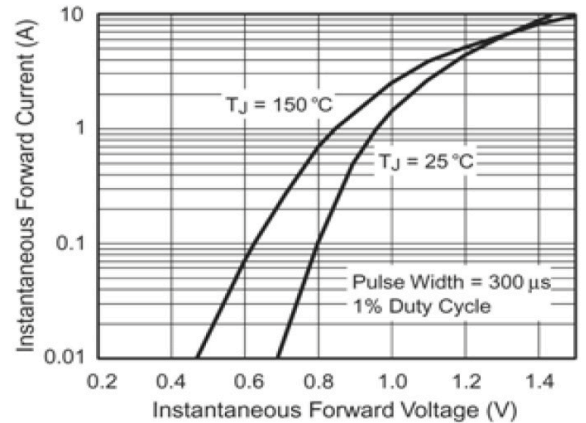

Figure 3. Typical Forward Voltage Characteristics Per Leg

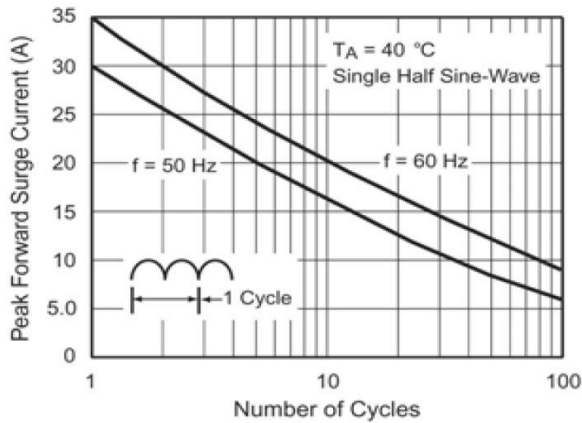

Figure 2. Maximum Non-Repetitive Peak Forward Surge Current Per Leg

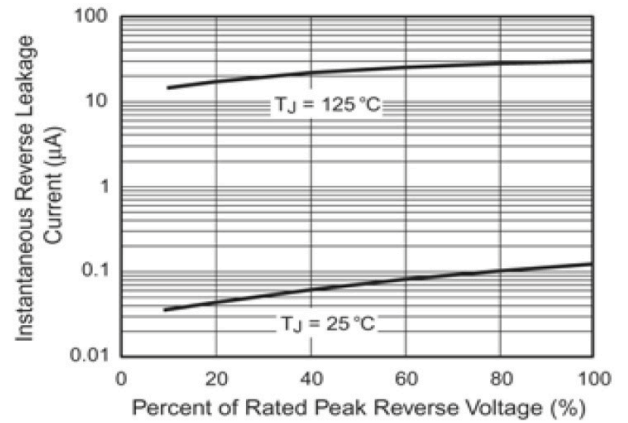

Figure 4. Typical Reverse Leakage Characteristics Per Leg

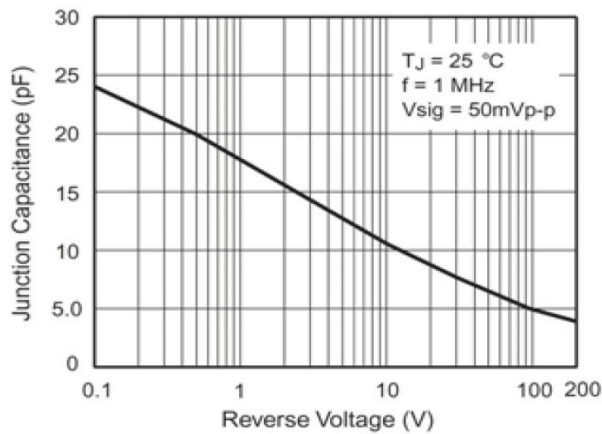

Figure 5. Typical Junction Capacitance Per Leg