

Product Specification

Surge Type
MBRB1060CT

Construction : Schottky Barrier Rectifier
Application : For General Purpose
(Manufacturer) :
Surge Components Inc.
Prepared on May. 10th, 2011
Prepared: R & D Department
Approval: QRA Department

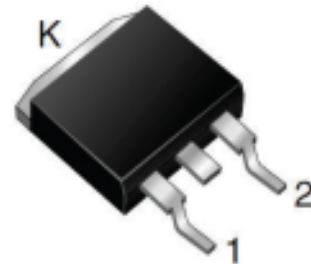

SCHOTTKY BARRIER RECTIFIER
10 AMPERES
60 VOLTS

CONTENTS

1. Package Outline
2. Marking
3. Features & Mechanical Characteristics
4. Maximum Ratings and Electrical Characteristics
5. Rating and characteristic Curves
6. Packing Specification PACKAGING SPECIFICATION
7. Description of Box Label

1. Package Outline (TO263)

UNIT:mm

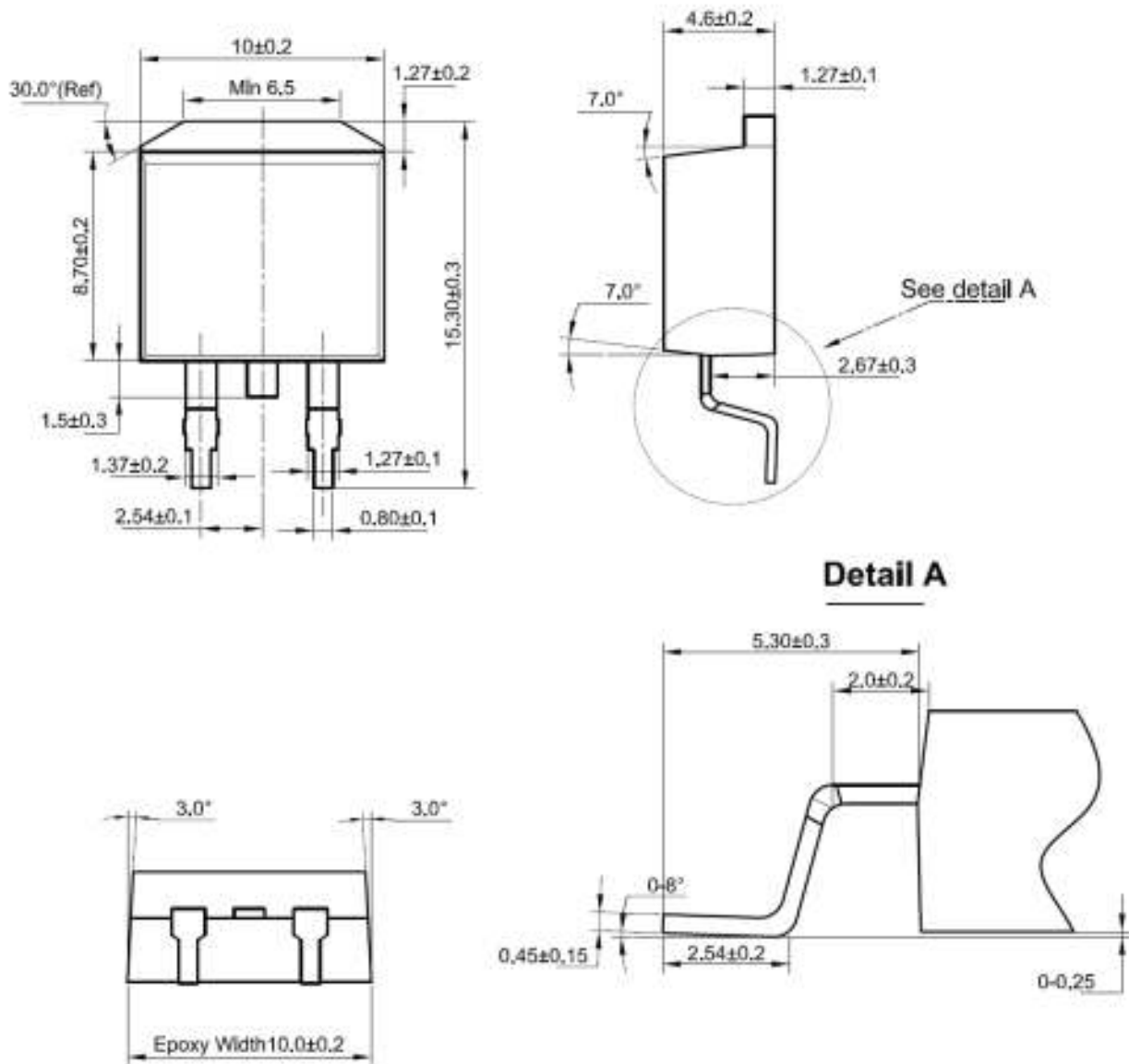

Lead Frame Material : Copper Plating: Pure Tin Plating

2.MARKING

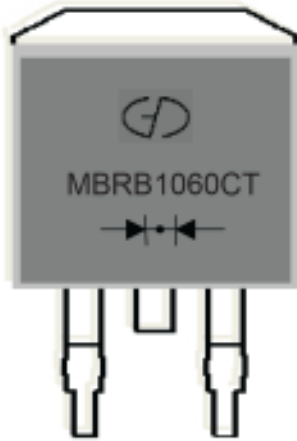

- | | |
|----------------|------------|
| 1. Part Name : | MBRB1060CT |
| 2. Logo Mark: | |
| 3. Polarity: | |



3.Features& Mechanical Characteristics

Features

- Plastic package has underwriters Laboratory Flammability Classification 94V-0
- For surface mounted application
- Metal of silicon rectifier, majority carrier conduction
- Low forward voltage, high efficiency
- Guarding for over voltage protection
- For use in low voltage, high frequency inverters,
- Free wheeling, and polarity protection applications

Mechanical Characteristics

- Case: Epoxy, Molded
- Weight: 1.4grams (approximately)
- Finish: All External Surfaces Corrosion Resistant and Terminal Leads are Readily Solderable
- Lead Temperature for Soldering Purposes: 260°C Max.for10 sec
- Shipped 50 units per plastic tube or tape reel packing 800/reel

4.Maximum Ratings and Electrical Characteristics

MAXIMUM RATINGS and ELECTRICAL CHARACTERISTICS(TC=25°C unless otherwise noted)					
PARAMETER	TEST CONDITIONS		SYMBOL	MBRB1060CT	UNIT
Maximum repetitive peak reverse voltage			VRRM	60	V
Working peak reverse voltage			VRWM	60	V
Maximum DC blocking voltage			VDC	60	V
Maximum average forward rectified current at Tc=105°C total device per diode			IF(AV)	10 5.0	A
Peak forward surge current 8.3ms single half sine-wave superimposed on rated load per diode			IFSM	125	A
Peak repetitive reverse current per leg at tp=2.0us , 1KHz			IRRM	0.5	A
Isolation voltage (TO220F-AB only) from terminal to heatsink t = 1 min			VAC	1500	V
Voltage rate of change (rated VR)			DV/dt	10000	V/us
Operating junction temperature range			TJ	-55 to +150	°C
Storage temperature range			TSTG	-55 to +150	°C
Maximum instantaneous forward voltage per leg	IF=5.0A IF=5.0A	Tc=25°C Tc=125°C	VF	0.80 0.70	V
Maximum reverse current per leg at working peak Reverse voltage			IR	100 10.0	uA mA

Thermal Characteristics Ta=25°C unless otherwise noted

Symbol	Parameter	Max	Unit
RθJC	Thermal Resistance, Junction to Case per Leg	2.0	°C /W

Note:

1. Pulse test:300us pulse width, duty cycle=2%



5. Rating and Characteristic Curves

(Tc=25°C Unless otherwise noted)

Rating and Characteristic Curves

(Tc=25°C unless otherwise noted)

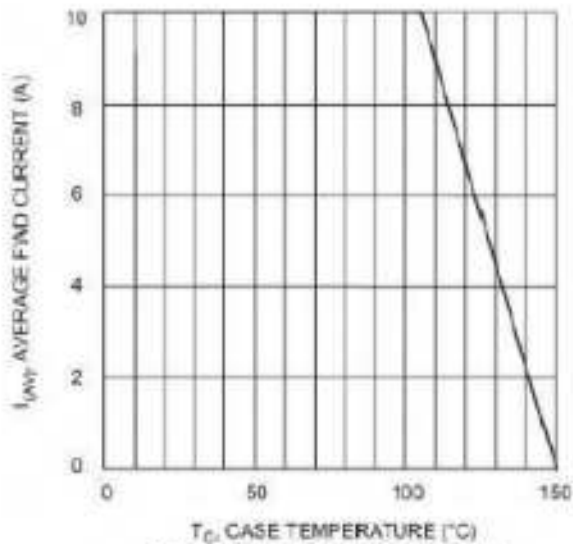

Fig. 1 Forward Current Derating Curve

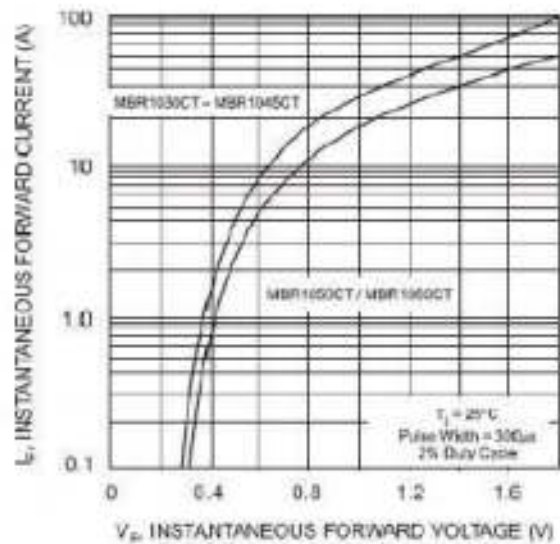

Fig. 2 Typical Forward Characteristics

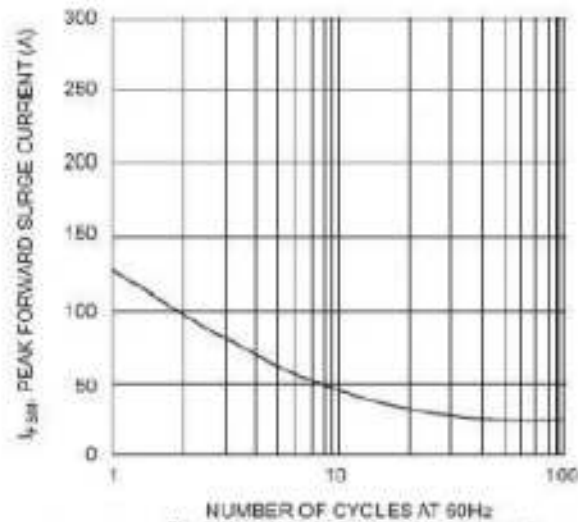

Fig. 3 Max Non-Repetitive Surge Current

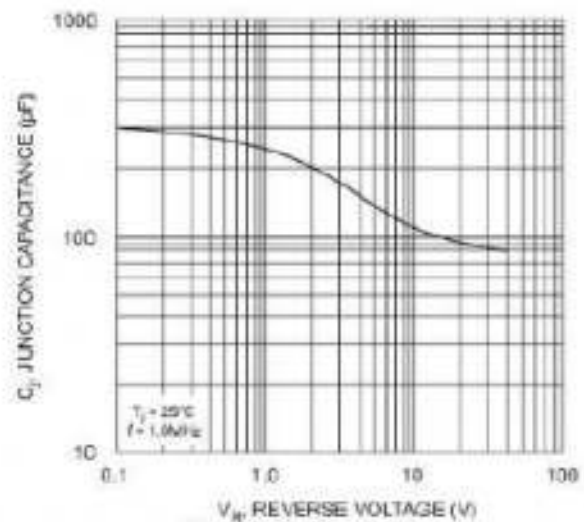

Fig. 4 Typical Junction Capacitance