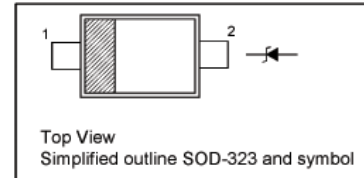

Silicon Planar Zener Diodes
Features

- Total power dissipation: Max. 300 mW
- Small plastic package suitable for surface mounted design
- Tolerance approximately $\pm 5\%$

PINNING

PIN	DESCRIPTION
1	Cathode
2	Anode

Absolute Maximum Ratings ($T_a = 25\text{ }^\circ\text{C}$)

Parameter	Symbol	Value	Unit
Power Dissipation	P_{tot}	300	mW
Junction Temperature	T_j	150	$^\circ\text{C}$
Storage Temperature Range	T_{stg}	- 55 to + 150	$^\circ\text{C}$

Characteristics at $T_a = 25\text{ }^\circ\text{C}$

Parameter	Symbol	Max.	Unit
Thermal Resistance Junction to Ambient Air	$R_{\theta JA}$	417	$^\circ\text{C/W}$
Forward Voltage at $I_F = 10\text{ mA}$	V_F	0.9	V

Characteristics at $T_a = 25\text{ }^\circ\text{C}$

Type	Marking Code	Zener Voltage Range ¹⁾			Dynamic Impedance			Reverse Current	
		V_{znom} V	I_{zT} mA	for V_{zT} V	Z_{zT} Ω (Max.)	Z_{zK} Ω (Max.)	at I_{zK} mA	I_R μA (Max.)	at V_R V
MM3Z5221B	A1	2.4	20	2.28...2.52	30	1200	0.25	100	1
MM3Z5223B	B1	2.7	20	2.57...2.84	30	1300	0.25	75	1
MM3Z5225B	C1	3.0	20	2.85...3.15	29	1600	0.25	50	1
MM3Z5226B	D1	3.3	20	3.14...3.47	28	1600	0.25	25	1
MM3Z5227B	E1	3.6	20	3.42...3.78	24	1700	0.25	15	1
MM3Z5228B	F1	3.9	20	3.71...4.1	23	1900	0.25	10	1
MM3Z5229B	H1	4.3	20	4.09...4.52	22	2000	0.25	5	1
MM3Z5230B	J1	4.7	20	4.47...4.94	19	1900	0.25	5	2
MM3Z5231B	K1	5.1	20	4.85...5.36	17	1600	0.25	5	2
MM3Z5232B	M1	5.6	20	5.32...5.88	11	1600	0.25	5	3
MM3Z5234B	N1	6.2	20	5.89...6.51	7	1000	0.25	5	4
MM3Z5235B	P1	6.8	20	6.46...7.14	5	750	0.25	3	5
MM3Z5236B	R1	7.5	20	7.13...7.88	6	500	0.25	3	6
MM3Z5237B	X1	8.2	20	7.79...8.61	8	500	0.25	3	6.5
MM3Z5239B	Y1	9.1	20	8.65...9.56	10	600	0.25	3	7
MM3Z5240B	Z1	10	20	9.5...10.5	17	600	0.25	3	8
MM3Z5241B	A2	11	20	10.45...11.55	22	600	0.25	2	8.4
MM3Z5242B	B2	12	20	11.4...12.6	30	600	0.25	1	9.1
MM3Z5243B	C2	13	9.5	12.35...13.65	13	600	0.25	0.5	9.9
MM3Z5245B	D2	15	8.5	14.25...15.75	16	600	0.25	0.1	11
MM3Z5246B	E2	16	7.8	15.2...16.8	17	600	0.25	0.1	12
MM3Z5248B	F2	18	7	17.1...18.9	21	600	0.25	0.1	14
MM3Z5249B	N9	19	6.6	18.05...19.95	23	600	0.25	0.1	14
MM3Z5250B	H2	20	6.2	19...21	25	600	0.25	0.1	15
MM3Z5251B	J2	22	5.6	20.9...23.1	29	600	0.25	0.1	17
MM3Z5252B	K2	24	5.2	22.8...25.2	33	600	0.25	0.1	18
MM3Z5253B	P9	25	5	23.75...26.25	35	600	0.25	0.1	19
MM3Z5254B	M2	27	4.6	25.65...28.35	41	600	0.25	0.1	21
MM3Z5256B	N2	30	4.2	28.5...31.5	49	600	0.25	0.1	23
MM3Z5257B	P2	33	3.8	31.35...34.65	58	700	0.25	0.1	25
MM3Z5258B	R2	36	3.4	34.2...37.8	70	700	0.25	0.1	27
MM3Z5259B	X2	39	3.2	37.05...40.95	80	800	0.25	0.1	30
MM3Z5260B	Y2	43	3	40.85...45.15	93	900	0.25	0.1	33
MM3Z5261B	Z2	47	2.7	44.65...49.35	105	1000	0.25	0.1	36
MM3Z5262B	A3	51	2.5	48.45...53.55	125	1100	0.25	0.1	39
MM3Z5263B	B3	56	2.2	53.2...58.8	150	1300	0.25	0.1	43
MM3Z5265B	C3	62	2	58.9...65.1	185	1400	0.25	0.1	47
MM3Z5266B	D3	68	1.8	64.6...71.4	230	1600	0.25	0.1	52
MM3Z5267B	E3	75	1.7	71.25...78.75	270	1700	0.25	0.1	56

¹⁾ V_Z is tested with pulses (20 ms)

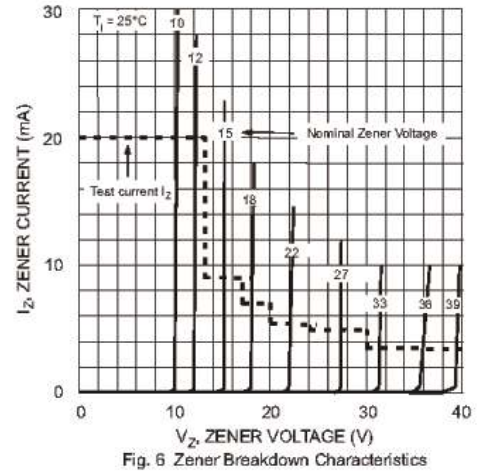
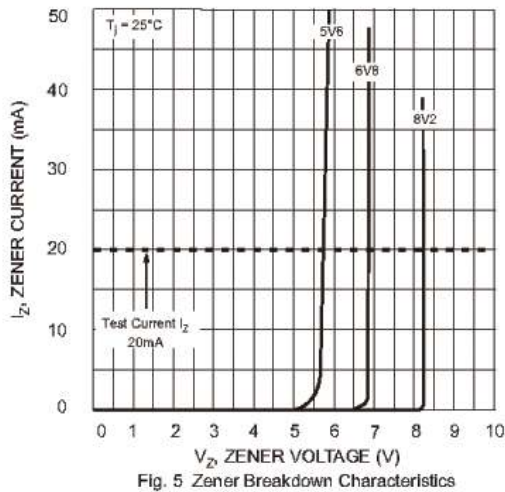
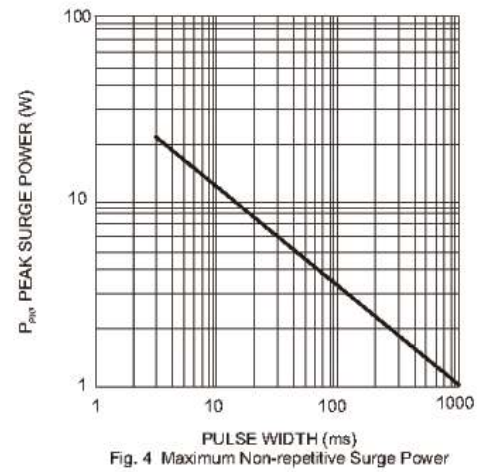
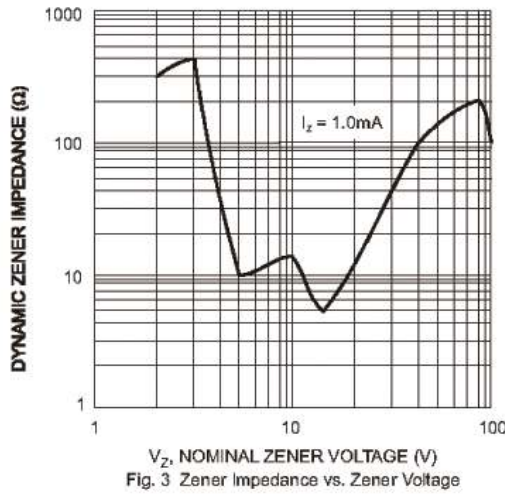
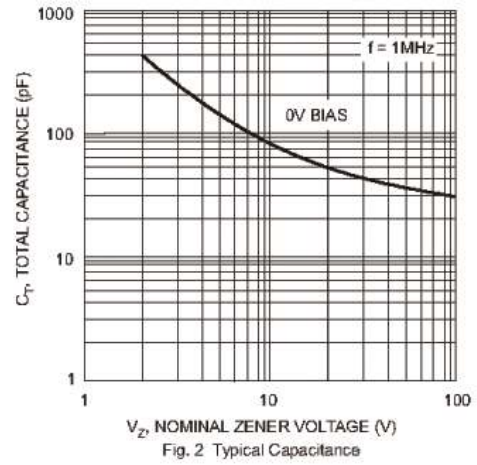
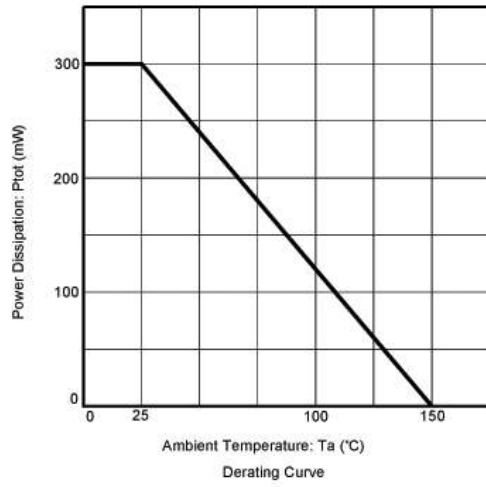

PACKAGE OUTLINE

Plastic surface mounted package; 2 leads

SOD-323

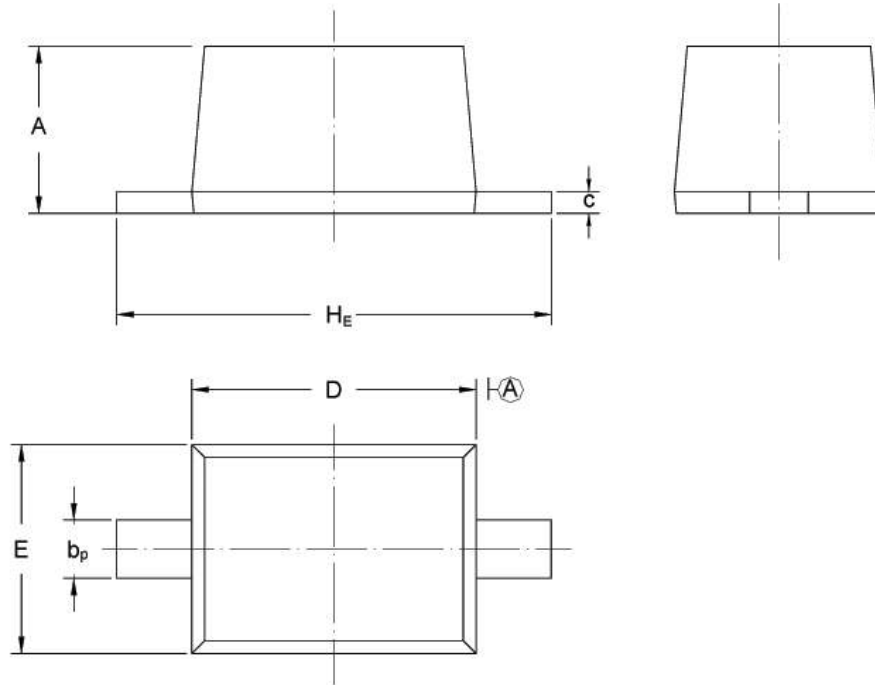

UNIT	A	b_p	C	D	E	H_E
mm	1.10 0.80	0.40 0.25	0.15 0.10	1.80 1.60	1.35 1.15	2.80 2.30