

## APPROVAL DRAWING

Surge Components product name
SES5VSC70-6 TR (RoHS compliant)

### CONTENTS

1. FEATURE
2. APPLICATION
3. ELECTRICAL CHARACTERISTICS
4. ABSOLUTE MAXIMUM RATING
5. TYPICAL CHARACTERISTICS
6. PRODUCT DIMENSION
7. PACKING INFORMATION
8. APPLICATION NOTE

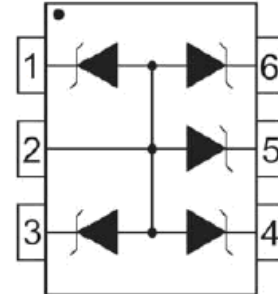
Surge Components, Inc.

Customer Acknowledgement
--------------------------

Manufacturer Surge Components, Inc.
2009-05-06

## 1. FEATURE

- 100 Watts Peak Power per Line( $t_p=8/20\mu s$ )
- SC-70-6L package
- Protect 4 lines bidirectional and 5 lines unidirectional
- Monolithic structure
- Working voltage: 5V
- Low clamping voltage
- ESD protection > 15KV
- Low leakage current
- RoHS compliant
- Transient protection for data lines to IEC 61000-4-2(ESD)  $\pm 15KV$  (air),  $\pm 8KV$  (contact); IEC 61000-4-4 (EFT) 40A (5/50ns)



## 2. APPLICATION

- Cellular phones
- MP3 players
- Notebook
- PDAs
- Digital cameras
- Cellular phones station

## 3. ELECTRICAL CHARACTERISTICS PER LINE@25°C (UNLESS OTHERWISE SPECIFIED)

Parameter	Symbol	Conditions	Min.	Typ.	Max.	Units
Reverse stand-off voltage	$V_{RWM}$				5	V
Reverse Breakdown voltage	$V_{BR}$	$I_t=1mA$	6			V
Reverse Leakage Current	$I_R$	$V_{RWM}=5V$ $T=25^\circ C$			5	$\mu A$
Clamping Voltage	$V_C$	$I_{PP}=1A$ $T_P=8/20\mu S$			8.8	V
Clamping voltage	$V_C$	$I_{PP}=10A$ $T_P=8/20\mu S$			10.0	V
Junction Capacitance	$C_J$	$V_R=0V$ $f=1MHz$		60		pF

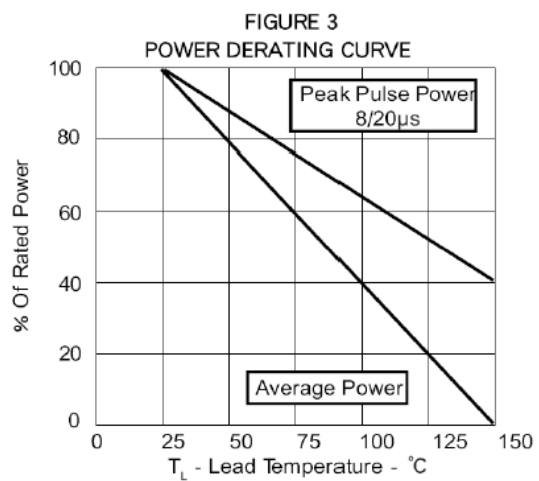
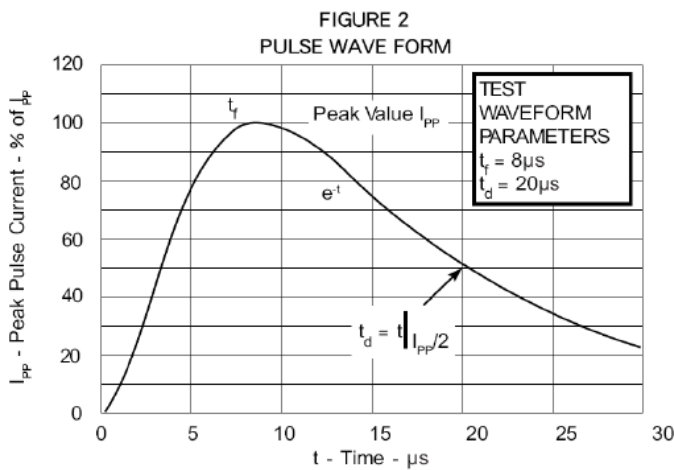
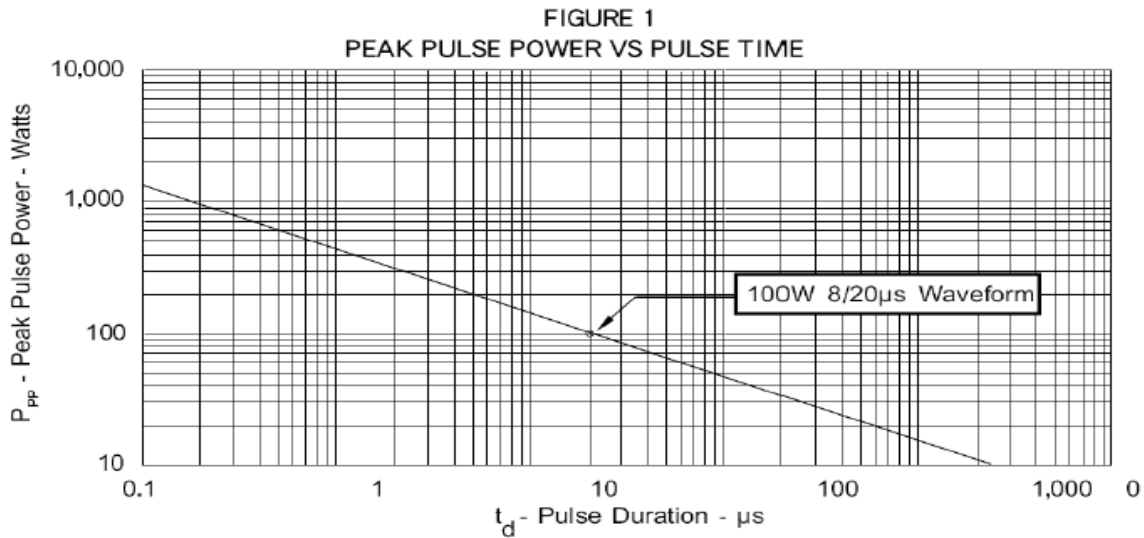
- Note 1: Pin 1,3,4,5 or 6 to Pin 2

#### 4. ABSOLUTE MAXIMUM RATING @25°C NOTE 1

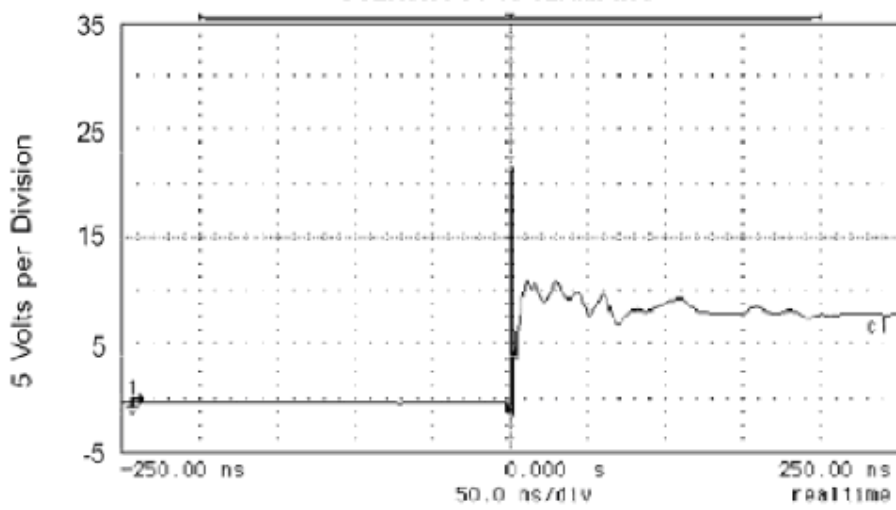
Rating	Symbol	Value	Units
Peak Pulse Power( $t_p=8/20\mu s$ )	$P_{PP}$	100	W
Forward voltage@1A, 8/20 $\mu s$	$V_F$	1.5	V
Operating Temperature	$T_j$	-55 to +150	°C
Storage Temperature	$T_{STG}$	-55 to +150	°C

- Note 1: Pin 1,3,4,5 or 6 to Pin 2

#### 5.TYPICAL CHARACTERISTICS

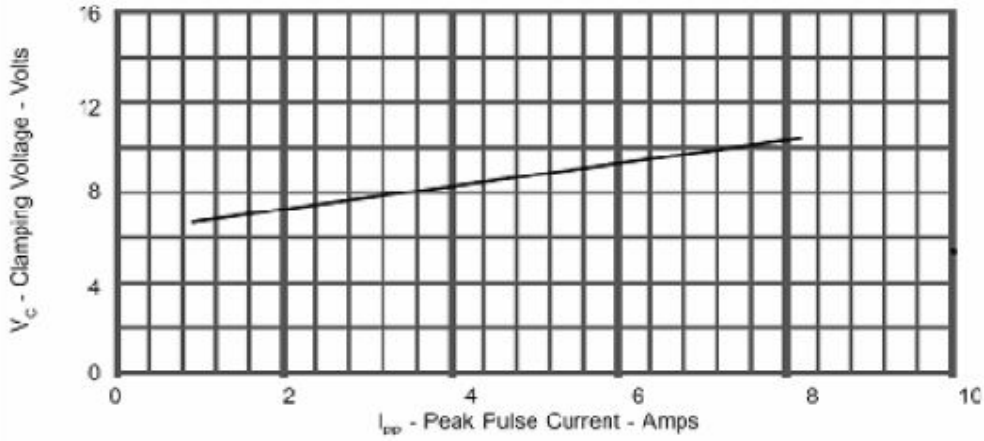


**FIGURE 4  
OVERSHOOT vs CLAMPING**

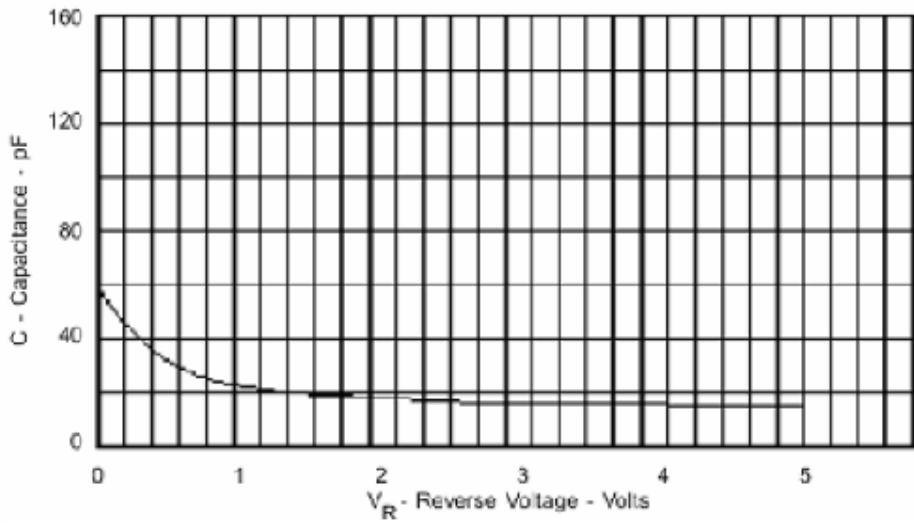


ESD Test Pulse: 5 kilovolt, 1/30ns (waveform)

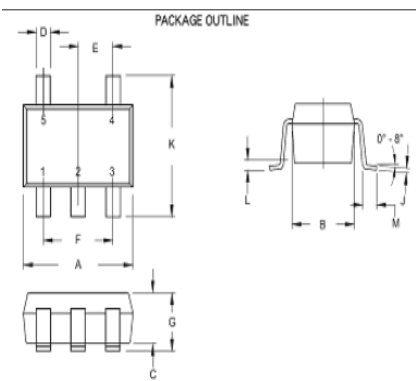

**FIGURE 5  
TYPICAL CLAMPING VOLTAGE vs PEAK PULSE CURRENT**



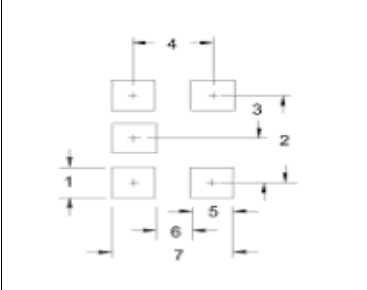
**FIGURE 6**  
**TYPICAL REVERSE VOLTAGE vs CAPACITANCE**



## 6. PRODUCT DIMENSION

 <p>PACKAGE OUTLINE</p>	<p><b>SC70-6L</b></p> 			
PACKAGE OUTLINE				
DIM	MILIMETER		INCHES	
	MIN	MAX	MIN	MAX
A	1.90	2.15	0.075	0.085
B	1.15	1.35	0.045	0.053
C	0.80	1.00	0.031	0.039
D	0.15	0.30	0.006	0.012
E	0.65 BSC	-	0.026 BSC	-
F	1.30 BSC	-	0.051 BSC	-
G	0.80	1.10	0.031	0.043
J	0.08	0.25	0.003	0.010
K	1.90	2.15	0.075	0.085
L	0	0.10	0	0.004
M	0.26	0.46	0.010	0.018

MOUNTING PAD		
TYPICAL		
DIM	Millimeter	Inches
1	0.50	0.020
2	1.30	0.051
3	0.65	0.026
4	1.72	0.068
5	0.60	0.024
6	1.11	0.044
7	2.33	0.092



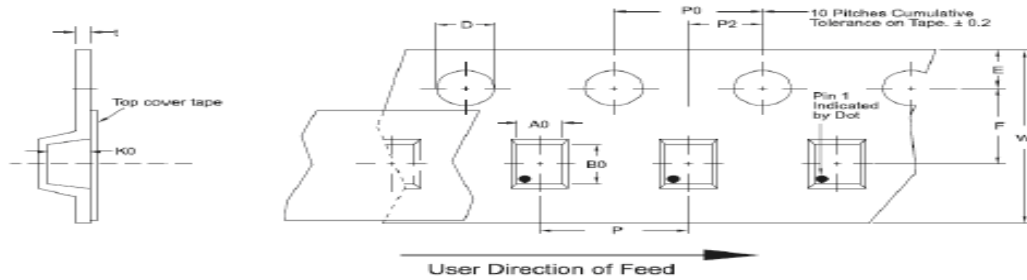
**NOTES**

**TAPE & REEL ORDERING NOMENCLATURE**

1. Surface mount product is taped and reeled in accordance with EIA-481.
2. 7 Inch Reel – 3,000 pieces per 8mm tape.

## 7. PACKING INFORMATION

Reel Dia	Tape Width	A0	B0	K0	D	E	F	W	P0	P2	P	lmax
178mm(7")	8mm	2.25±0.10	2.34±0.10	1.22±0.10	1.50±0.10	1.75±0.10	3.50±0.05	8.00±0.30	4.00±0.10	2.00±0.005	4.00±0.005	0.25



## 8. APPLICATION NOTE

The SES5VSC70-6 is TVS arrays designed to protect I/O or data lines from the damaging effects of ESD or EFT. This product provides both unidirectional and bidirectional protection, with a surge capability of 100 watts Ppp line for an 8/20µs wave shape and ESD protection > 25kv.

Common-mode unidirectional configuration (Figure 1)

The SES5VSC70-6 provides up to 5 lines of protection in a common-mode unidirectional configuration as depicted in Figure 1.

Circuit connectivity is as follows:

- Line 1 is connected to Pin1.
- Line 2 is connected to Pin3.
- Line 3 is connected to Pin4.
- Line 4 is connected to Pin6
- Line 5 is connected to Pin5.
- Pin2 is connected to ground.

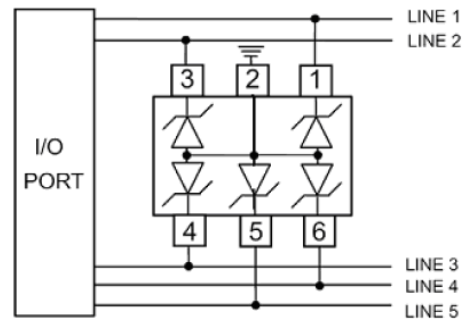


Figure 1

Common-mode unidirectional configuration (Figure 2)

The SES5VSC70-6 provides up to 4 lines of protection in a common-mode bidirectional configuration as depicted in Figure 2.

Circuit connectivity is as follows:

- Line 1 is connected to Pin1.
- Line 2 is connected to Pin3.
- Line 3 is connected to Pin4
- Line 4 is connected to Pin6
- Pin5 is connected to ground.
- Pin2 is not connected.

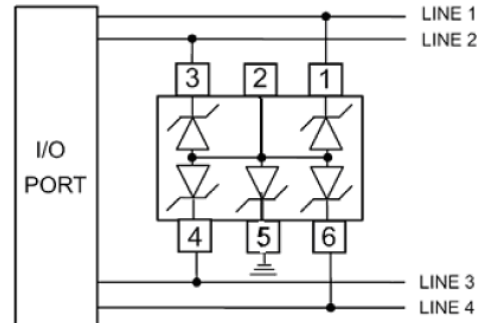


Figure 2

Differential-mode bidirectional configuration (Figure 3)

The SES5VSC70-5 provides up to 4 lines of protection in a differential-mode bidirectional configuration as depicted in Figure 3.

Circuit connectivity is as follows:

- Line 1 is connected to Pin1.
- Line 2 is connected to Pin3.
- Line 3 is connected to Pin4.
- Line 4 is connected to Pin6.
- Line 5 is connected to Pin5.
- Pin2 is not connected.

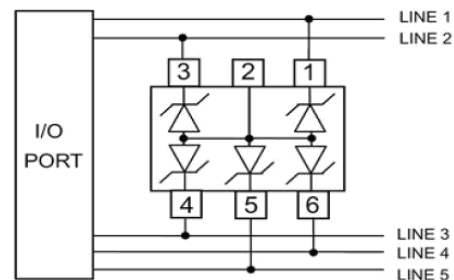


Figure 3

Circuit board layout and protection device placement:

Circuit board layout is critical for suppression of ESD transients.

The following guidelines are recommended:

1. Place the protection devices as close to the input terminal or connector as possible.
2. The path length between the protection device and protected line should be minimized.
3. Keep parallel signal paths to a minimum.
4. Avoid running protection conductors in parallel with unprotected conductor.
5. Minimize all printed-circuit board conductive loops including power and ground loops.
6. minimize the length of the transient return path to ground.
7. Avoid using shared transient return paths to common ground point.
8. Ground planes should be used whenever possible. For multilayer printed-circuit boards, use ground vias