

# ILLUMINATED SWITCH SML6-H1 SERIES

Tact Switch  
Illuminated



2018

ILLUMINATED SWITCH

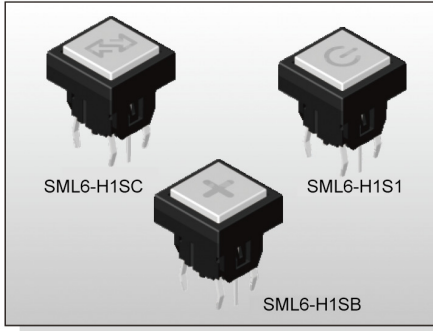

## FEATURES

- ✳ Customized cap options
- ✳ Bi-color LED available
- ✳ Long operating life

## APPLICATION

- ✳ Sever, modem, data storage
- ✳ Audio module
- ✳ Office equipment

## SPECIFICATION

Contact Rating	50mA, 12V DC
Contact Resistance	100mΩ max.
Insulation Resistance	100MΩ min. 100V DC
Dielectric Strength	250V AC/1 minute
Operating Force	160±50gf
Travel	0.25mm
Operating Life	300,000 cycles
Operating Temp.	-40°C ~ +85°C
Storage Temp.	-40°C ~ +85°C

## HOW TO ORDER

**S M L 6 - H 1**    **V A**

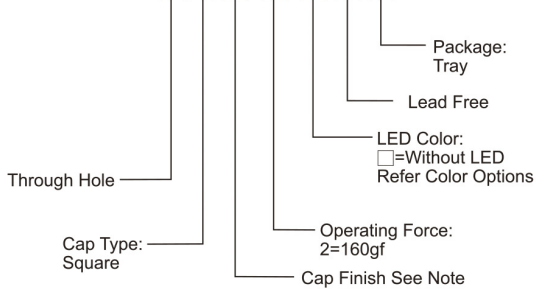

## CIRCUIT

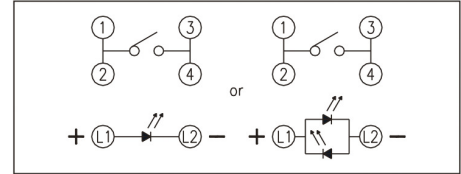

## PACKAGE

<Tray>  
100 pcs.

## SML6-H1

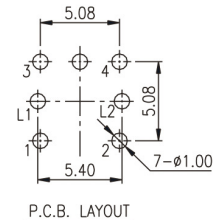
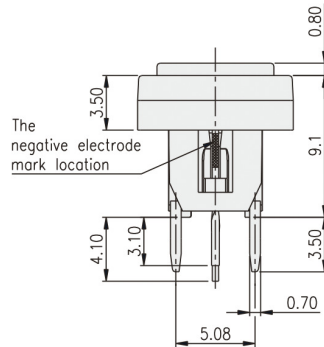
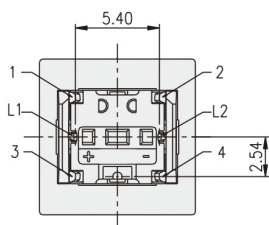
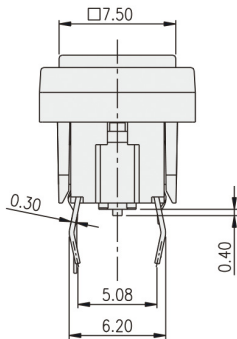
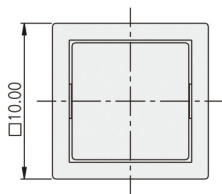

## LED Color Options:

Part No.	Color	Dominant Wavelength $\lambda_p$ Typ.(nm)	Luminous Intensity $I_v$ (mcd)	Forward Voltage $V_f$ (V)		View Angle $2\theta_{1/2}$ (Degree)
			Typ.	Typ.	Max.	
B	Blue	470	70	3.0	3.6	140°
PG	Pure Gree	520	160	3.2	3.6	
G	Yellow Green	570	30	2.0	2.3	
Y	Yellow	590	60	2.0	2.3	
A	Soft Orange	605	50	2.0	2.3	
R	Red	630	60	2.0	2.3	
W	Cold White	X:0.30 / Y:0.30	350	3.0	3.6	

Note :

Mark	CAP	
	Mark	Color
S1		Silver
S2	Reset	Silver
SA	-	Silver
SB	+	Silver