

Features

- ◆ Thin Single In-Line package
- ◆ Ideal for printed circuit boards
- ◆ Glass passivated chip junction
- ◆ High surge current capability
- ◆ High case dielectric strength of 2500 V_{RMS}
- ◆ Plastic package has Underwriters Laboratory Flammability Classification 94V-0

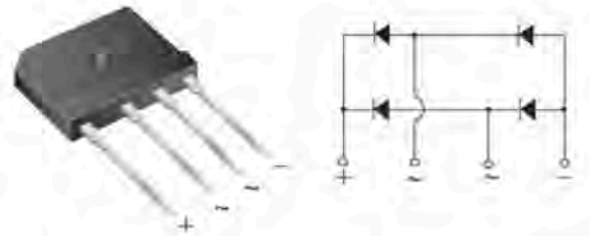

Mechanical Data

- ◆ Case: GBJ(5S)
Epoxy meets UL-94V-0 Flammability rating
- ◆ Terminals: Plated leads solderable per MIL-STD-750, Method 2026
- ◆ High temperature soldering guaranteed:
260°C/10 seconds, 0.375 (9.5mm) lead length, 5lbs. (2.3kg) tension
- ◆ Polarity: As marked on body
- ◆ Mounting Torque: 10 cm·kg (8.8 inches·lbs) max.
- ◆ Recommended Torque: 5.7cm·kg (5 inches·lbs)

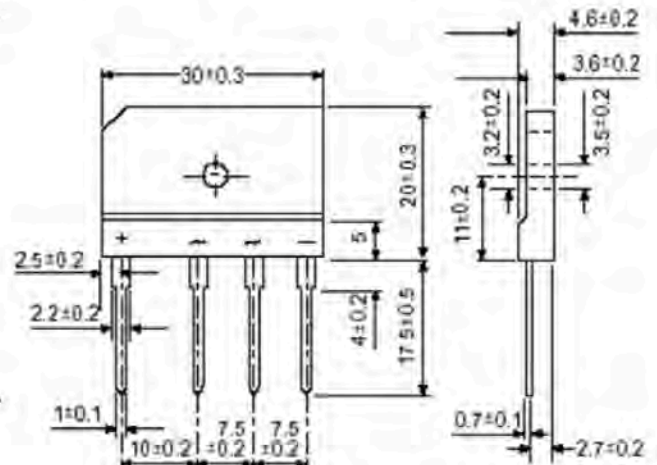

Package outline dimensions in millimeters

Typical Applications

General purpose use in ac-to-dc bridge full wave rectification for Switching Power Supply, Home Appliances, Office Equipment, Industrial Automation applications

Maximum Ratings and Electrical Characteristics

Rating at 25°C ambient temperature unless otherwise specified.

Parameter	Symbols	GBJ15AU	GBJ15BU	GBJ15DU	GBJ15GU	GBJ15JU	GBJ15KU	GBJ15MU	Units
Maximum repetitive peak reverse voltage	V_{RRM}	50	100	200	400	600	800	1000	Volts
Maximum RMS voltage	V_{RMS}	35	70	140	280	420	560	700	Volts
Maximum DC blocking voltage	V_{DC}	50	100	200	400	600	800	1000	Volts
Maximum average forward rectified output current at $T_C=107^\circ\text{C}$ $T_A=25^\circ\text{C}$	$I_{F(AV)}$				15 ⁽¹⁾				Amps
Peak forward surge current, 8.3ms single half sine-wave superimposed on rated load (JEDEC Method)	I_{FSM}				240				Amps
Rating for fusing (t<8.3ms)	I^2t				240				A ² sec
Maximum instantaneous forward voltage drop per leg at 7.5A	V_F				1.0				Volt
Maximum DC reverse current at rated DC blocking voltage per leg $T_A=25^\circ\text{C}$ $T_A=125^\circ\text{C}$	I_R				5 250				μA
Typical thermal resistance per leg	$R_{\theta JA}$ $R_{\theta JC}$				22 ⁽²⁾ 1.5 ⁽¹⁾				°C/W
Dielectric strength (Terminals to case, AC 1 minute)	V_{ISO}				2500				Volts
Operating junction and storage temperature range	T_{JF} T_{STG}				-55 to +150				°C

- Notes:**
1. Unit case mounted on 18.5x18.5x0.15cm thick Al plate heatsink
 2. Units mounted on P.C.B. without heatsink
 3. Recommended mounting position is to bolt down on heatsink with silicone thermal compound for maximum heat transfer with #6 screw

RATINGS AND CHARACTERISTIC CURVES

($T_A = 25^\circ\text{C}$ unless otherwise noted)

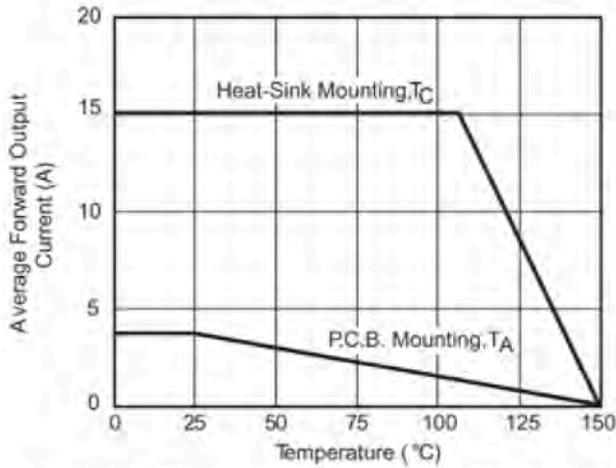

Figure 1. Derating Curve Output Rectified Current

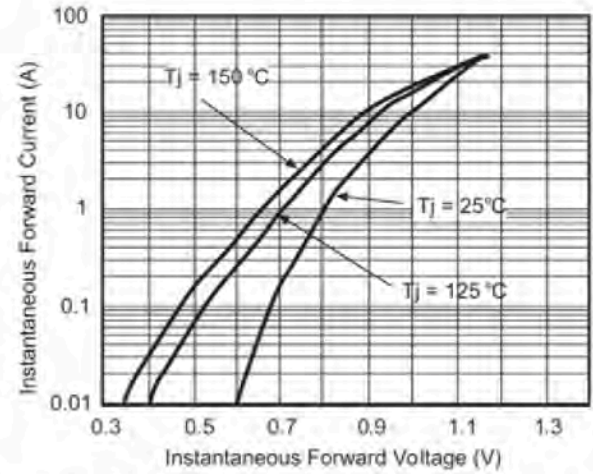

Figure 3. Typical Forward Characteristics Per Leg

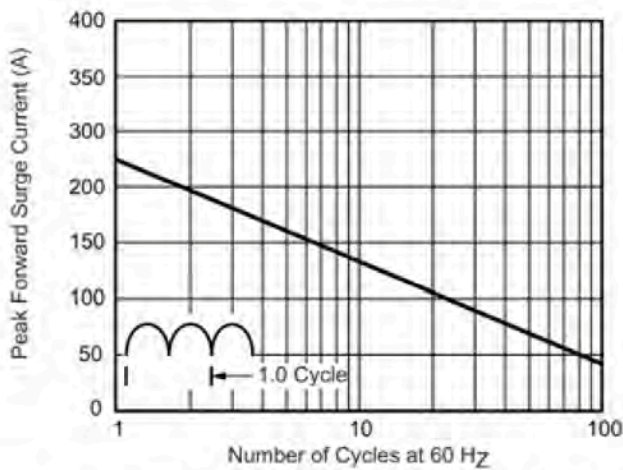

Figure 2. Maximum Non-Repetitive Peak Forward Surge Current Per Leg

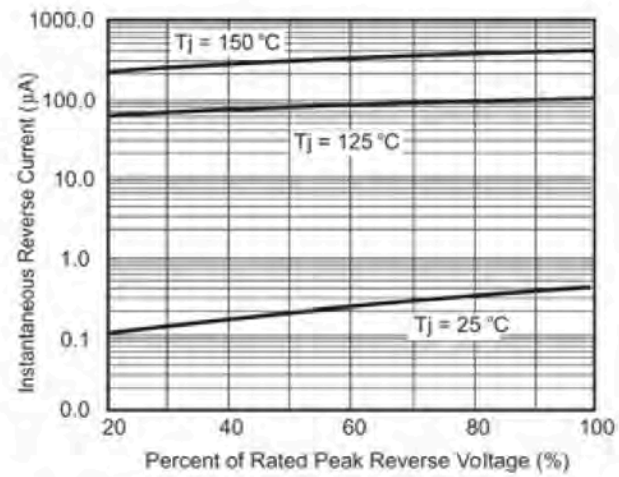

Figure 4. Typical Reverse Characteristics Per Leg

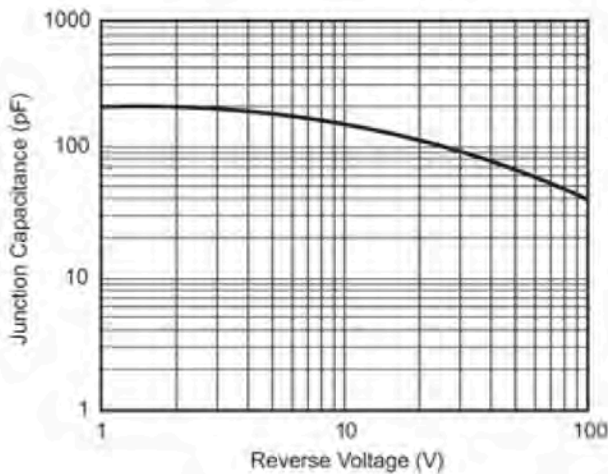

Figure 5. Typical Junction Capacitance Per Leg

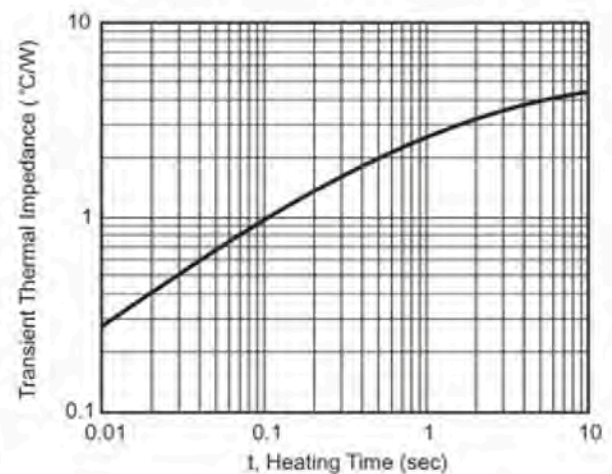

Figure 6. Typical Transient Thermal Impedance