

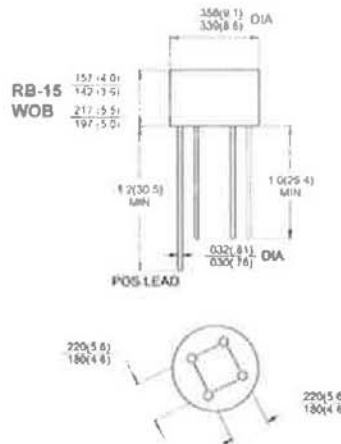

Glass Passivated Single-Phase Bridge Rectifiers
Reverse Voltage 50 to 1000 Volts Forward Current 1.5 Amperes

Features

- ◆ Surge overload ratings to 40 or 50 amperes peak
- ◆ Ideal for printed circuit board
- ◆ Reliable low cost construction technique results in inexpensive product
- ◆ High temperature soldering guaranteed:
260°C / 10 seconds / 0.375" (9.5mm)
lead length at 5 lbs. (2.3 kg) tension



Package outline dimensions in inches (millimeters)

Mechanical Data

- ◆ Case: Molded plastic
- ◆ Lead: solder plated
- ◆ Polarity: As marked
- ◆ Weight: 1.07 grams (RB-15), 1.10 grams (WOB)

Maximum Ratings and Electrical Characteristics

Rating at 25°C ambient temperature unless otherwise specified.

Single phase, half wave, 60 Hz, resistive or inductive load.

For capacitive load, derate current by 20%

Parameter	Symbols	RB151	RB152	RB153	RB154	RB155	RB156	RB157	Units
		W005	W01	W02	W04	W06	W08	W10	
		W005M	W01M	W02M	W04M	W06M	W08M	W10M	
		W005G	W01G	W02G	W04G	W06G	W08G	W10G	
		W005GM	W01GM	W02GM	W04GM	W06GM	W08GM	W10GM	
Maximum recurrent peak reverse voltage	V_{RRM}	50	100	200	400	600	800	1000	Volts
Maximum RMS voltage	V_{RMS}	35	70	140	280	420	560	700	Volts
Maximum DC blocking voltage	V_{DC}	50	100	200	400	600	800	1000	Volts
Maximum average forward rectified current at $T_A=50^\circ\text{C}$	$I_{F(AV)}$	1.5							Amps
Peak forward surge current, 8.3ms single half sine-wave superimposed on rated load (JEDEC Method)	I_{FSM}	Wxxx or WxxxM 40.0, RB15x, WxxxG & WxxxGM 50.00							Amps
Max. instantaneous forward voltage drop per element at 0.75A	V_F	1.0							Volt
Maximum DC reverse current $T_A=25^\circ\text{C}$ at rated DC blocking voltage per element	I_R	10.0 500 (RB15x, Wxxx, WxxxM @ $T_A=100^\circ\text{C}$, WxxxG or WxxxGM @ $T_A=125^\circ\text{C}$)							μA
Typical thermal resistance per leg (Note 1)	$R_{\theta JA}$ $R_{\theta JL}$	36 13							$^\circ\text{C/W}$
Operating junction temperature range	T_J	Wxxx or WxxxM -55 to +125, RB15x, WxxxG & WxxxGM -55 to +150							$^\circ\text{C}$
Storage temperature range	T_{STG}	-55 to +150							$^\circ\text{C}$

Notes: 1. Thermal resistance from junction to ambient and from junction to lead mounted on P.C.B. with 0.2 x 0.2" (5 x 5mm) copper pads



RATINGS AND CHARACTERISTIC CURVES

($T_A = 25^\circ\text{C}$ unless otherwise noted) - W005 thru W10

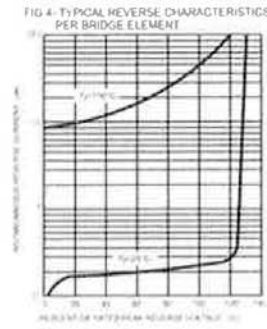
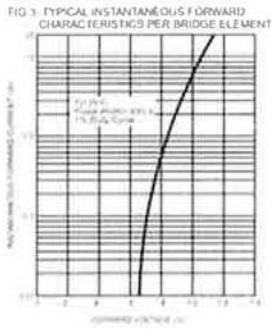
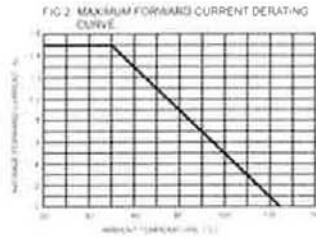
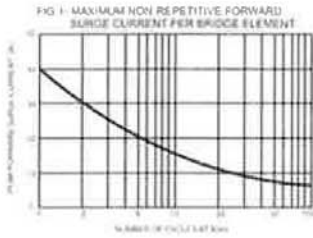

($T_A = 25^\circ\text{C}$ unless otherwise noted) - W005M thru W10M

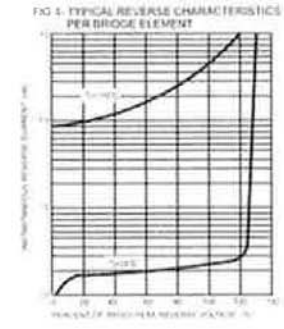
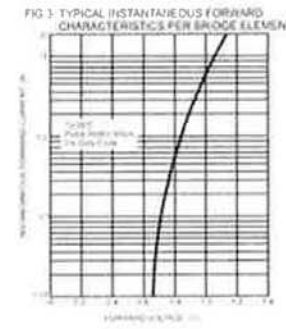
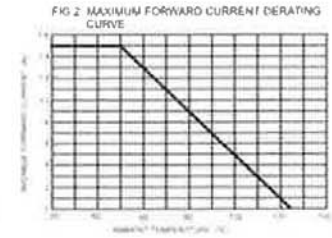
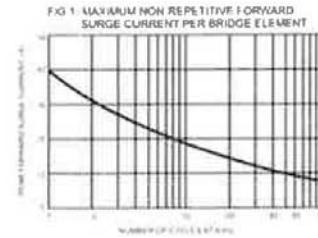

($T_A = 25^\circ\text{C}$ unless otherwise noted) - RB151 thru RB157, W005G thru W10G

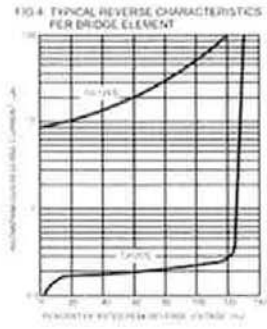
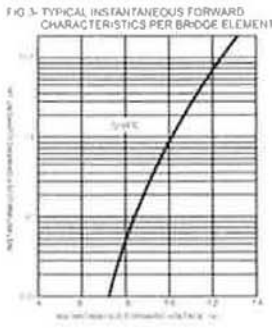
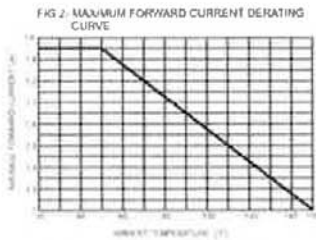
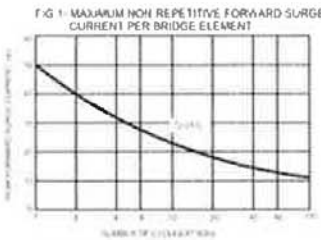

($T_A = 25^\circ\text{C}$ unless otherwise noted) - W005GM thru W10GM

