

FEATURES

- ※ Compact-sized 2.9x3.9mm
- ※ Vertical or side actuation
- ※ Reflow solderable

APPLICATION

- ※ Automotive
- ※ Portable electronic device
- ※ Control panel

SPECIFICATION

Contact Rating	50mA, 12V DC
Contact Resistance	100mΩ max.
Insulation Resistance	100MΩ min. 100V DC
Dielectric Strength	100V AC/1 minute
Operating Force	160±50gf (Vertical Push) 220±65gf (Side Push)
Travel	0.13mm (Vertical Push) 0.20mm (Side Push)
Operating Life	100,000 cycles
Operating Temp.	-20°C ~ +70°C
Storage Temp.	-30°C ~ +80°C

HOW TO ORDER

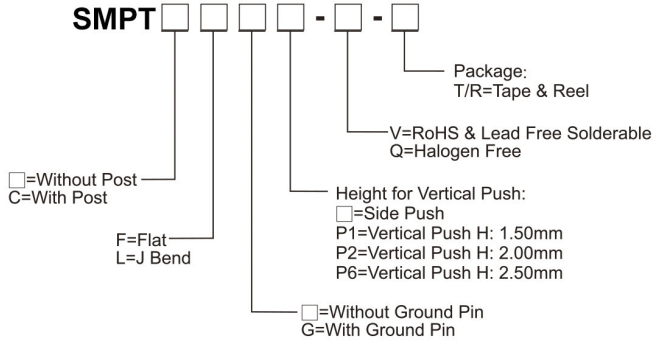

CIRCUIT

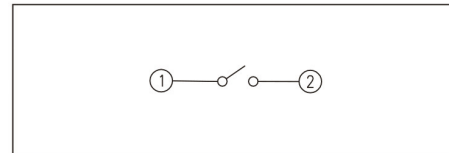

PACKAGE

<Tape & Reel>
Side push: 3500 pcs
Vertical push: 2000 pcs

TACT SWITCH

SMPTFP

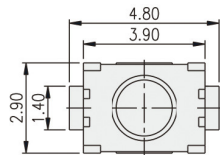

PART NO.	H
SMPTFP1	1.50
SMPTFP2	2.00
SMPTFP6	2.50

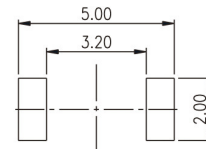

P.C.B. LAYOUT

SMPTCLG

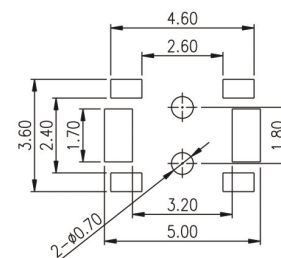
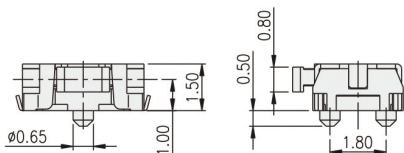
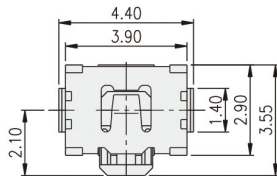

P.C.B. LAYOUT