



SPECIFICATION FOR APPROVAL

Product Name	Metallized polypropylene Film Capacitor A.C. Applications
Product Type	C33(MKP23 Series)
Product Code	
Customer	
Customer Code	
Issue Date	2013-10

Metallized polypropylene film capacitor (Box-type)

■ Outline Drawing

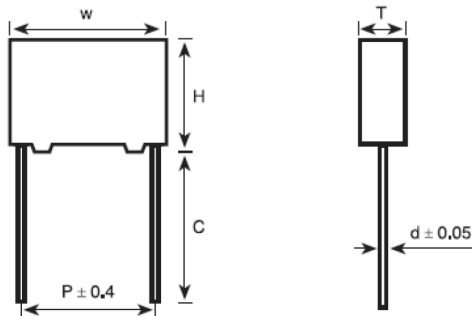

$$W \pm 0.4, H \pm 0.4, T \pm 0.4$$

■ Features

- Low loss at high frequency
- Small inherent temperature rise, high temperature rang
- Plastic case (UL94 V-0), Epoxy resin sealing

■ Typical application

- Pulse applications with high A.C. voltage and high current
- Electric lighting(i.e. Electric ballast, E-HID)
- High-frequence A.C. loads

■ Specifications

Reference Standard	GB/T 14579 (IEC 60384-17)				
Climatic Category	55/125/56				
Rated temperature	105℃				
Operating temperature range	-55℃~125℃ (+105℃ to +125℃: decreasing factor 1.25% per ℃ for U_R)				
Capacitance Range	0.00047μF ~ 0.15μF				
Capacitance Tolerance	±3%(H), ±5%(J), ±10%(K)				
Voltage Proof	1.6 U_R (5s)				
Dissipation Factor	≤0.0010 (20℃, 1kHz)				
Insulation Resistance	≥100 000MΩ (20℃, 100V, 1min)				
Maximum Pulse Rise Time(dV/dt) If the working voltage(U) is lower than the rated voltage(U_R),the capacitor can be worked at a higher dV/dt. In this case, the maximum allowed dV/dt is obtain by multiplying the right value with U_R/U .	U_R (Vac)	dV/dt(V/us)			
		P=7.5	P=10.0	P=15.0	P=22.5
	400	3 000	2 200	2 000	800
	500	4 000	3 000	2 500	1 200
	600	6 500	6 000	4 500	1 800
	700	--	9 800	9 500	4 500
900	--	--	10 000	6 000	

Rated Voltage	400Vac		500Vac		600Vac		700Vac		900Vac
Pitch(mm)	7.5	>7.5	7.5	>7.5	≤10.0	>10.0	10.0	>10.0	---
VDC(V)	1000	1300	1300	1400	1400	1600	1600	2000	2500

■ Part number system

The 18 digits part number is formed as follow:

1	2	3	4	5	6	7	8	9	10	11	12	13	14	15	16	17	18
C	3	3															

Digit 1 to 3 Series code

C33=MKP23

Digit 4 to 5 AC rated voltage

G2=400V H2=500V U1=600V

V1=700V X1=900V

Digit 6 to 8 Rated capacitance value

For example: 103=10×10³pF=0.01uF

Digit 9 Capacitance tolerance

H=±3%,J=±5%,K=±10%,

Digit 10 Pitch

3=7.5mm 4=10mm 6=15mm 9=22.5mm

Digit 11 Internal use

Digit 12 to 15 Lead form and packing code

Digit 16 to 18 Internal use

Table 1 lead form and packing code

Digit 12		Digit 13		Digit 14		Digit 15	
code	explanation	code	explanation	code	explanation	code	explanation
A	ammo-pack	3	F=7.5mm	0	straight	1	each cap. among two consecutive holes P3=12.7mm,H=18.5mm (For pitch=5.0/7.5mm)
		4	F=10.0mm			5	P3=25.4mm;H=18.5mm (For pitch=10/15mm)
C	straight lead “C” in the figure above	code	explanation	00		0	Length tolerance ±0.5mm (or standard length)
		45	lead length 4.5mm			2	Length tolerance ±0.3mm
		35	lead length 3.5mm				
		32	lead length 3.2mm				

■ Dimensions(mm)

400Vac							
C _N (μF)	W ±0.4	H ±0.4	T ±0.4	P ±0.4	d	max dV/dt (v/μs)	Part Number
0.00082	10.5	9.0	4.0	7.5	0.6	3 000	C33G2821-30*****++
0.0010	10.5	9.0	4.0	7.5	0.6	3 000	C33G2102-30*****++
0.0012	10.5	9.0	4.0	7.5	0.6	3 000	C33G2122-30*****++
0.0015	10.5	9.0	4.0	7.5	0.6	3 000	C33G2152-30*****++
0.0018	10.5	9.0	4.0	7.5	0.6	3 000	C33G2182-30*****++
0.0022	10.5	9.0	4.0	7.5	0.6	3 000	C33G2222-30*****++
0.0027	10.5	9.0	4.0	7.5	0.6	3 000	C33G2272-30*****++
0.0033	10.5	9.0	4.0	7.5	0.6	3 000	C33G2332-30*****++
0.0036	10.5	9.0	4.0	7.5	0.6	3 000	C33G2362-30*****++
0.0039	10.5	9.0	4.0	7.5	0.6	3 000	C33G2392-30*****++
0.0047	10.5	9.0	4.0	7.5	0.6	3 000	C33G2472-30*****++
0.0056	10.5	11.0	5.0	7.5	0.6	3 000	C33G2562-30*****++
0.0068	10.5	11.0	5.0	7.5	0.6	3 000	C33G2682-30*****++
0.0082	10.5	11.0	5.0	7.5	0.6	3 000	C33G2822-30*****++
0.010	10.5	12.0	6.0	7.5	0.6	3 000	C33G2103-30*****++
0.012	10.5	12.0	6.0	7.5	0.6	3 000	C33G2123-30*****++
0.0010	13.0	9.0	4.0	10.0	0.6	2 200	C33G2102-40*****++
0.0012	13.0	9.0	4.0	10.0	0.6	2 200	C33G2122-40*****++
0.0015	13.0	9.0	4.0	10.0	0.6	2 200	C33G2152-40*****++
0.0018	13.0	9.0	4.0	10.0	0.6	2 200	C33G2182-40*****++
0.0022	13.0	9.0	4.0	10.0	0.6	2 200	C33G2222-40*****++
0.0027	13.0	9.0	4.0	10.0	0.6	2 200	C33G2272-40*****++
0.0033	13.0	9.0	4.0	10.0	0.6	2 200	C33G2332-40*****++
0.0039	13.0	9.0	4.0	10.0	0.6	2 200	C33G2392-40*****++
0.0047	13.0	11.0	5.0	10.0	0.6	2 200	C33G2472-40*****++
0.0056	13.0	11.0	5.0	10.0	0.6	2 200	C33G2562-40*****++
0.0068	13.0	11.0	5.0	10.0	0.6	2 200	C33G2682-40*****++
0.0082	13.0	12.0	6.0	10.0	0.6	2 200	C33G2822-40*****++
0.010	13.0	12.0	6.0	10.0	0.6	2 200	C33G2103-40*****++

400Vac							
C _N (μF)	W ±0.4	H ±0.4	T ±0.4	P ±0.4	d	max dV/dt (v/μs)	Part Number
0.0022	17.5	11.0	5.0	15.0	0.8	2 000	C33G2222-60*****++
0.0027	17.5	11.0	5.0	15.0	0.8	2 000	C33G2272-60*****++
0.0033	17.5	11.0	5.0	15.0	0.8	2 000	C33G2332-60*****++
0.0039	17.5	11.0	5.0	15.0	0.8	2 000	C33G2392-60*****++
0.0047	17.5	11.0	5.0	15.0	0.8	2 000	C33G2472-60*****++
0.0056	17.5	11.0	5.0	15.0	0.8	2 000	C33G2562-60*****++
0.0068	17.5	11.0	5.0	15.0	0.8	2 000	C33G2682-60*****++
0.0082	17.5	11.0	5.0	15.0	0.8	2 000	C33G2822-60*****++
0.010	17.5	11.0	5.0	15.0	0.8	2 000	C33G2103-60*****++
0.012	17.5	11.0	5.0	15.0	0.8	2 000	C33G2123-60*****++
0.015	17.5	12.0	6.0	15.0	0.8	2 000	C33G2153-60*****++
0.018	17.5	12.0	6.0	15.0	0.8	2 000	C33G2183-60*****++
0.022	17.5	13.5	7.5	15.0	0.8	2 000	C33G2223-60*****++
0.027	17.5	13.5	7.5	15.0	0.8	2 000	C33G2273-60*****++
0.033	17.5	14.5	8.5	15.0	0.8	2 000	C33G2333-60*****++
0.039	17.5	16.0	10.0	15.0	0.8	2 000	C33G2393-60*****++
0.047	17.5	16.0	10.0	15.0	0.8	2 000	C33G2473-60*****++
0.056	17.5	19.0	11.0	15.0	0.8	2 000	C33G2563-60*****++
0.068	17.5	19.0	11.0	15.0	0.8	2 000	C33G2683-60*****++
0.018	26.5	15.0	6.0	22.5	0.8	800	C33G2183-90*****++
0.022	26.5	15.0	6.0	22.5	0.8	800	C33G2223-90*****++
0.027	26.5	15.0	6.0	22.5	0.8	800	C33G2273-90*****++
0.033	26.5	15.0	6.0	22.5	0.8	800	C33G2333-90*****++
0.039	26.5	15.0	6.0	22.5	0.8	800	C33G2393-90*****++
0.047	26.5	16.0	7.0	22.5	0.8	800	C33G2473-90*****++
0.056	26.5	16.0	7.0	22.5	0.8	800	C33G2563-90*****++
0.068	26.5	17.0	8.5	22.5	0.8	800	C33G2683-90*****++
0.082	26.5	17.0	8.5	22.5	0.8	800	C33G2823-90*****++
0.10	26.5	18.5	10.0	22.5	0.8	800	C33G2104-90*****++
0.12	26.5	22.0	12.0	22.5	0.8	800	C33G2124-90*****++
0.15	26.5	22.0	12.0	22.5	0.8	800	C33G2154-90*****++

- Note: 1. “-”=capacitance tolerance code, K=±10%,J=±5%, H=±3%
 2. “*****”=lead form and packing code (refer to table 1)

■ Dimensions(mm)

500Vac							
C _N (μF)	W ±0.4	H ±0.4	T ±0.4	P ±0.4	d	max dV/dt (v/μs)	Part Number
0.00056	10.5	9.0	4.0	7.5	0.6	4 000	C33H2561-3S*****++
0.00062	10.5	9.0	4.0	7.5	0.6	4 000	C33H2621-3S*****++
0.00068	10.5	9.0	4.0	7.5	0.6	4 000	C33H2681-3S*****++
0.00082	10.5	9.0	4.0	7.5	0.6	4 000	C33H2821-3S*****++
0.0010	10.5	9.0	4.0	7.5	0.6	4 000	C33H2102-3S*****++
0.0012	10.5	9.0	4.0	7.5	0.6	4 000	C33H2122-3S*****++
0.0015	10.5	9.0	4.0	7.5	0.6	4 000	C33H2152-3S*****++
0.0018	10.5	9.0	4.0	7.5	0.6	4 000	C33H2182-3S*****++
0.0022	10.5	11.0	5.0	7.5	0.6	4 000	C33H2222-3S*****++
0.0027	10.5	11.0	5.0	7.5	0.6	4 000	C33H2272-3S*****++
0.0033	10.5	11.0	5.0	7.5	0.6	4 000	C33H2332-3S*****++
0.0036	10.5	12.0	6.0	7.5	0.6	4 000	C33H2362-3S*****++
0.0039	10.5	12.0	6.0	7.5	0.6	4 000	C33H2392-3S*****++
0.0047	10.5	12.0	6.0	7.5	0.6	4 000	C33H2472-3S*****++
0.0056	10.5	12.0	6.0	7.5	0.6	4 000	C33H2562-3S*****++
0.0010	13.0	9.0	4.0	10.0	0.6	3 000	C33H2102-4S*****++
0.0012	13.0	9.0	4.0	10.0	0.6	3 000	C33H2122-4S*****++
0.0015	13.0	9.0	4.0	10.0	0.6	3 000	C33H2152-4S*****++
0.0018	13.0	9.0	4.0	10.0	0.6	3 000	C33H2182-4S*****++
0.0022	13.0	9.0	4.0	10.0	0.6	3 000	C33H2222-4S*****++
0.0027	13.0	9.0	4.0	10.0	0.6	3 000	C33H2272-4S*****++
0.0030	13.0	9.0	4.0	10.0	0.6	3 000	C33H2302-4S*****++
0.0033	13.0	9.0	4.0	10.0	0.6	3 000	C33H2332-4S*****++
0.0039	13.0	11.0	5.0	10.0	0.6	3 000	C33H2392-4S*****++
0.0047	13.0	11.0	5.0	10.0	0.6	3 000	C33H2472-4S*****++
0.0056	13.0	11.0	5.0	10.0	0.6	3 000	C33H2562-4S*****++
0.0068	13.0	12.0	6.0	10.0	0.6	3 000	C33H2682-4S*****++
0.0082	13.0	12.0	6.0	10.0	0.6	3 000	C33H2822-4S*****++
0.010	13.0	13.0	7.0	10.0	0.6	3 000	C33H2103-4S*****++
0.012	13.0	14.0	8.0	10.0	0.6	3 000	C33H2123-4S*****++

500Vac							
C _N (μF)	W ±0.4	H ±0.4	T ±0.4	P ±0.4	d	max dV/dt (v/μs)	Part Number
0.0033	17.5	11.0	5.0	15.0	0.8	2 500	C33H2332-6S*****++
0.0036	17.5	11.0	5.0	15.0	0.8	2 500	C33H2362-6S*****++
0.0039	17.5	11.0	5.0	15.0	0.8	2 500	C33H2392-6S*****++
0.0047	17.5	11.0	5.0	15.0	0.8	2 500	C33H2472-6S*****++
0.0056	17.5	11.0	5.0	15.0	0.8	2 500	C33H2562-6S*****++
0.0068	17.5	11.0	5.0	15.0	0.8	2 500	C33H2682-6S*****++
0.0082	17.5	11.0	5.0	15.0	0.8	2 500	C33H2822-6S*****++
0.010	17.5	11.0	5.0	15.0	0.8	2 500	C33H2103-6S*****++
0.012	17.5	12.0	6.0	15.0	0.8	2 500	C33H2123-6S*****++
0.015	17.5	12.0	6.0	15.0	0.8	2 500	C33H2153-6S*****++
0.018	17.5	13.5	7.5	15.0	0.8	2 500	C33H2183-6S*****++
0.022	17.5	13.5	7.5	15.0	0.8	2 500	C33H2223-6S*****++
0.027	17.5	13.5	7.5	15.0	0.8	2 500	C33H2273-6S*****++
0.030	17.5	14.5	8.5	15.0	0.8	2 500	C33H2303-6S*****++
0.033	17.5	16.0	10.0	15.0	0.8	2 500	C33H2333-6S*****++
0.036	17.5	16.0	10.0	15.0	0.8	2 500	C33H2363-6S*****++
0.039	17.5	16.0	10.0	15.0	0.8	2 500	C33H2393-6S*****++
0.047	17.5	19.0	11.0	15.0	0.8	2 500	C33H2473-6S*****++
0.056	17.5	19.0	11.0	15.0	0.8	2 500	C33H2563-6S*****++
0.010	26.5	15.0	6.0	22.5	0.8	1 200	C33H2103-9S*****++
0.012	26.5	15.0	6.0	22.5	0.8	1 200	C33H2123-9S*****++
0.015	26.5	15.0	6.0	22.5	0.8	1 200	C33H2153-9S*****++
0.018	26.5	15.0	6.0	22.5	0.8	1 200	C33H2183-9S*****++
0.022	26.5	15.0	6.0	22.5	0.8	1 200	C33H2223-9S*****++
0.027	26.5	15.0	6.0	22.5	0.8	1 200	C33H2273-9S*****++
0.033	26.5	16.0	7.0	22.5	0.8	1 200	C33H2333-9S*****++
0.036	26.5	16.0	7.0	22.5	0.8	1 200	C33H2363-9S*****++
0.039	26.5	16.0	7.0	22.5	0.8	1 200	C33H2393-9S*****++
0.047	26.5	17.0	8.5	22.5	0.8	1 200	C33H2473-9S*****++
0.056	26.5	17.0	8.5	22.5	0.8	1 200	C33H2563-9S*****++
0.068	26.5	18.5	10.0	22.5	0.8	1 200	C33H2683-9S*****++
0.082	26.5	18.5	10.0	22.5	0.8	1 200	C33H2823-9S*****++
0.10	26.5	22.0	12.0	22.5	0.8	1 200	C33H2104-9S*****++
0.12	26.5	22.0	12.0	22.5	0.8	1 200	C33H2124-9S*****++

- Note: 1. “-”=capacitance tolerance code, K=±10%,J=±5%,H=±3%
 2. “*****”=lead form and packing code (refer to table 1)

■ Dimensions(mm)

600Vac							
C _N (μF)	W ±0.4	H ±0.4	T ±0.4	P ±0.4	d	max dV/dt (v/μs)	Part Number
0.00047	10.5	9.0	4.0	7.5	0.6	6 500	C33U1471-30****+++
0.00056	10.5	9.0	4.0	7.5	0.6	6 500	C33U1561-30****+++
0.00062	10.5	9.0	4.0	7.5	0.6	6 500	C33U1621-30****+++
0.00068	10.5	9.0	4.0	7.5	0.6	6 500	C33U1681-30****+++
0.00082	10.5	9.0	4.0	7.5	0.6	6 500	C33U1821-30****+++
0.0010	10.5	9.0	4.0	7.5	0.6	6 500	C33U1102-30****+++
0.0012	10.5	9.0	4.0	7.5	0.6	6 500	C33U1122-30****+++
0.0015	10.5	9.0	4.0	7.5	0.6	6 500	C33U1152-30****+++
0.0018	10.5	11.0	5.0	7.5	0.6	6 500	C33U1182-30****+++
0.0022	10.5	11.0	5.0	7.5	0.6	6 500	C33U1222-30****+++
0.0027	10.5	11.0	5.0	7.5	0.6	6 500	C33U1272-30****+++
0.0033	10.5	12.0	6.0	7.5	0.6	6 500	C33U1332-30****+++
0.0036	10.5	12.0	6.0	7.5	0.6	6 500	C33U1362-30****+++
0.0039	10.5	12.0	6.0	7.5	0.6	6 500	C33U1392-30****+++
0.0047	10.5	12.0	6.0	7.5	0.6	6 500	C33U1472-30****+++
0.00056	13.0	9.0	4.0	10.0	0.6	6 000	C33U1561-40****+++
0.00062	13.0	9.0	4.0	10.0	0.6	6 000	C33U1621-40****+++
0.00068	13.0	9.0	4.0	10.0	0.6	6 000	C33U1681-40****+++
0.00082	13.0	9.0	4.0	10.0	0.6	6 000	C33U1821-40****+++
0.0010	13.0	9.0	4.0	10.0	0.6	6 000	C33U1102-40****+++
0.0011	13.0	9.0	4.0	10.0	0.6	6 000	C33U1112-40****+++
0.0012	13.0	9.0	4.0	10.0	0.6	6 000	C33U1122-40****+++
0.0013	13.0	9.0	4.0	10.0	0.6	6 000	C33U1132-40****+++
0.0015	13.0	9.0	4.0	10.0	0.6	6 000	C33U1152-40****+++
0.0017	13.0	9.0	4.0	10.0	0.6	6 000	C33U1172-40****+++
0.0018	13.0	9.0	4.0	10.0	0.6	6 000	C33U1182-40****+++
0.0020	13.0	9.0	4.0	10.0	0.6	6 000	C33U1202-40****+++
0.0022	13.0	9.0	4.0	10.0	0.6	6 000	C33U1222-40****+++
0.0027	13.0	9.0	4.0	10.0	0.6	6 000	C33U1272-40****+++
0.0030	13.0	9.0	4.0	10.0	0.6	6 000	C33U1302-40****+++
0.0033	13.0	9.0	4.0	10.0	0.6	6 000	C33U1332-40****+++
0.0036	13.0	11.0	5.0	10.0	0.6	6 000	C33U1362-40****+++
0.0039	13.0	11.0	5.0	10.0	0.6	6 000	C33U1392-40****+++
0.0047	13.0	11.0	5.0	10.0	0.6	6 000	C33U1472-40****+++
0.0056	13.0	11.0	5.0	10.0	0.6	6 000	C33U1562-40****+++
0.0068	13.0	12.0	6.0	10.0	0.6	6 000	C33U1682-40****+++
0.0082	13.0	12.0	6.0	10.0	0.6	6 000	C33U1822-40****+++
0.010	13.0	13.0	7.0	10.0	0.6	6 000	C33U1103-40****+++
0.012	13.0	14.0	8.0	10.0	0.6	6 000	C33U1123-40****+++

600Vac							
C _N (μF)	W ±0.4	H ±0.4	T ±0.4	P ±0.4	d	max dV/dt (v/μs)	Part Number
0.0010	17.5	11.0	5.0	15.0	0.8	4 500	C33U1102-60****+++
0.0012	17.5	11.0	5.0	15.0	0.8	4 500	C33U1122-60****+++
0.0015	17.5	11.0	5.0	15.0	0.8	4 500	C33U1152-60****+++
0.0018	17.5	11.0	5.0	15.0	0.8	4 500	C33U1182-60****+++
0.0022	17.5	11.0	5.0	15.0	0.8	4 500	C33U1222-60****+++
0.0027	17.5	11.0	5.0	15.0	0.8	4 500	C33U1272-60****+++
0.0033	17.5	11.0	5.0	15.0	0.8	4 500	C33U1332-60****+++
0.0039	17.5	11.0	5.0	15.0	0.8	4 500	C33U1392-60****+++
0.0047	17.5	11.0	5.0	15.0	0.8	4 500	C33U1472-60****+++
0.0056	17.5	11.0	5.0	15.0	0.8	4 500	C33U1562-60****+++
0.0068	17.5	11.0	5.0	15.0	0.8	4 500	C33U1682-60****+++
0.0082	17.5	12.0	6.0	15.0	0.8	4 500	C33U1822-60****+++
0.010	17.5	12.0	6.0	15.0	0.8	4 500	C33U1103-60****+++
0.012	17.5	12.0	6.0	15.0	0.8	4 500	C33U1123-60****+++
0.015	17.5	13.5	7.5	15.0	0.8	4 500	C33U1153-60****+++
0.018	17.5	13.5	7.5	15.0	0.8	4 500	C33U1183-60****+++
0.022	17.5	14.5	8.5	15.0	0.8	4 500	C33U1223-60****+++
0.027	17.5	16.0	10.0	15.0	0.8	4 500	C33U1273-60****+++
0.033	17.5	16.0	10.0	15.0	0.8	4 500	C33U1333-60****+++
0.039	17.5	19.0	11.0	15.0	0.8	4 500	C33U1393-60****+++
0.047	17.5	19.0	11.0	15.0	0.8	4 500	C33U1473-60****+++
0.015	26.5	15.0	6.0	22.5	0.8	1 800	C33U1153-90****+++
0.018	26.5	15.0	6.0	22.5	0.8	1 800	C33U1183-90****+++
0.022	26.5	15.0	6.0	22.5	0.8	1 800	C33U1223-90****+++
0.027	26.5	16.0	7.0	22.5	0.8	1 800	C33U1273-90****+++
0.033	26.5	16.0	7.0	22.5	0.8	1 800	C33U1333-90****+++
0.039	26.5	17.0	8.5	22.5	0.8	1 800	C33U1393-90****+++
0.047	26.5	18.5	10.0	22.5	0.8	1 800	C33U1473-90****+++
0.056	26.5	18.5	10.0	22.5	0.8	1 800	C33U1563-90****+++
0.068	26.5	22.0	12.0	22.5	0.8	1 800	C33U1683-90****+++
0.082	26.5	22.0	12.0	22.5	0.8	1 800	C33U1823-90****+++
0.10	26.5	22.0	12.0	22.5	0.8	1 800	C33U1104-90****+++

- Note: 1. “-”=capacitance tolerance code, K=±10%,J=±5%,H=±3%
 2. “****”=lead form and packing code (refer to table 1)

■ Dimensions(mm)

700Vac							
C _N (μF)	W ±0.4	H ±0.4	T ±0.4	P ±0.4	d	max dV/dt (v/μs)	Part Number
0.00056	13.0	9.0	4.0	10.0	0.6	9 800	C33V1561-40****+++
0.00062	13.0	9.0	4.0	10.0	0.6	9 800	C33V1621-40****+++
0.00068	13.0	9.0	4.0	10.0	0.6	9 800	C33V1681-40****+++
0.00082	13.0	9.0	4.0	10.0	0.6	9 800	C33V1821-40****+++
0.0010	13.0	9.0	4.0	10.0	0.6	9 800	C33V1102-40****+++
0.0012	13.0	9.0	4.0	10.0	0.6	9 800	C33V1122-40****+++
0.0015	13.0	11.0	5.0	10.0	0.6	9 800	C33V1152-40****+++
0.0018	13.0	11.0	5.0	10.0	0.6	9 800	C33V1182-40****+++
0.0022	13.0	11.0	5.0	10.0	0.6	9 800	C33V1222-40****+++
0.0027	13.0	11.0	5.0	10.0	0.6	9 800	C33V1272-40****+++
0.0033	13.0	12.0	6.0	10.0	0.6	9 800	C33V1332-40****+++
0.0036	13.0	12.0	6.0	10.0	0.6	9 800	C33V1362-40****+++
0.0039	13.0	12.0	6.0	10.0	0.6	9 800	C33V1392-40****+++
0.0047	13.0	13.0	7.0	10.0	0.6	9 800	C33V1472-40****+++
0.0056	13.0	13.0	7.0	10.0	0.6	9 800	C33V1562-40****+++
0.0068	13.0	14.0	8.0	10.0	0.6	9 800	C33V1682-40****+++
0.0082	13.0	14.0	8.0	10.0	0.6	9 800	C33V1822-40****+++
0.00056	17.5	11.0	5.0	15.0	0.8	9 500	C33V1561-60****+++
0.00062	17.5	11.0	5.0	15.0	0.8	9 500	C33V1621-60****+++
0.00068	17.5	11.0	5.0	15.0	0.8	9 500	C33V1681-60****+++
0.00082	17.5	11.0	5.0	15.0	0.8	9 500	C33V1821-60****+++
0.0010	17.5	11.0	5.0	15.0	0.8	9 500	C33V1102-60****+++
0.0012	17.5	11.0	5.0	15.0	0.8	9 500	C33V1122-60****+++
0.0015	17.5	11.0	5.0	15.0	0.8	9 500	C33V1152-60****+++
0.0018	17.5	11.0	5.0	15.0	0.8	9 500	C33V1182-60****+++
0.0022	17.5	11.0	5.0	15.0	0.8	9 500	C33V1222-60****+++
0.0027	17.5	11.0	5.0	15.0	0.8	9 500	C33V1272-60****+++
0.0033	17.5	11.0	5.0	15.0	0.8	9 500	C33V1332-60****+++
0.0039	17.5	11.0	5.0	15.0	0.8	9 500	C33V1392-60****+++
0.0047	17.5	11.0	5.0	15.0	0.8	9 500	C33V1472-60****+++
0.0056	17.5	12.0	6.0	15.0	0.8	9 500	C33V1562-60****+++
0.0068	17.5	12.0	6.0	15.0	0.8	9 500	C33V1682-60****+++
0.0082	17.5	13.5	7.5	15.0	0.8	9 500	C33V1822-60****+++
0.010	17.5	13.5	7.5	15.0	0.8	9 500	C33V1103-60****+++
0.012	17.5	14.5	8.5	15.0	0.8	9 500	C33V1123-60****+++
0.015	17.5	14.5	8.5	15.0	0.8	9 500	C33V1153-60****+++
0.018	17.5	16.0	10.0	15.0	0.8	9 500	C33V1183-60****+++
0.022	17.5	19.0	11.0	15.0	0.8	9 500	C33V1223-60****+++
0.0068	26.5	15.0	6.0	22.5	0.8	4 500	C33V1682-90****+++
0.0082	26.5	15.0	6.0	22.5	0.8	4 500	C33V1822-90****+++
0.010	26.5	15.0	6.0	22.5	0.8	4 500	C33V1103-90****+++
0.012	26.5	15.0	6.0	22.5	0.8	4 500	C33V1123-90****+++
0.015	26.5	15.0	6.0	22.5	0.8	4 500	C33V1153-90****+++
0.018	26.5	16.0	7.0	22.5	0.8	4 500	C33V1183-90****+++
0.022	26.5	17.0	8.5	22.5	0.8	4 500	C33V1223-90****+++
0.027	26.5	17.0	8.5	22.5	0.8	4 500	C33V1273-90****+++
0.033	26.5	18.5	10.0	22.5	0.8	4 500	C33V1333-90****+++
0.039	26.5	18.5	10.0	22.5	0.8	4 500	C33V1393-90****+++
0.047	26.5	22.0	12.0	22.5	0.8	4 500	C33V1473-90****+++
0.056	26.5	22.0	12.0	22.5	0.8	4 500	C33V1563-90****+++

900Vac							
C _N (μF)	W ±0.4	H ±0.4	T ±0.4	P ±0.4	d	max dV/dt (v/μs)	Part Number
0.00056	17.5	11.0	5.0	15.0	0.8	10 000	C33X1561-60****+++
0.00068	17.5	11.0	5.0	15.0	0.8	10 000	C33X1681-60****+++
0.00082	17.5	11.0	5.0	15.0	0.8	10 000	C33X1821-60****+++
0.0010	17.5	11.0	5.0	15.0	0.8	10 000	C33X1102-60****+++
0.0012	17.5	11.0	5.0	15.0	0.8	10 000	C33X1122-60****+++
0.0015	17.5	11.0	5.0	15.0	0.8	10 000	C33X1152-60****+++
0.0018	17.5	11.0	5.0	15.0	0.8	10 000	C33X1182-60****+++
0.0022	17.5	11.0	5.0	15.0	0.8	10 000	C33X1222-60****+++
0.0027	17.5	11.0	5.0	15.0	0.8	10 000	C33X1272-60****+++
0.0033	17.5	11.0	5.0	15.0	0.8	10 000	C33X1332-60****+++
0.0039	17.5	12.0	6.0	15.0	0.8	10 000	C33X1392-60****+++
0.0047	17.5	12.0	6.0	15.0	0.8	10 000	C33X1472-60****+++
0.0056	17.5	12.0	6.0	15.0	0.8	10 000	C33X1562-60****+++
0.0068	17.5	13.5	7.5	15.0	0.8	10 000	C33X1682-60****+++
0.0082	17.5	13.5	7.5	15.0	0.8	10 000	C33X1822-60****+++
0.010	17.5	14.5	8.5	15.0	0.8	10 000	C33X1103-60****+++
0.012	17.5	16.0	10.0	15.0	0.8	10 000	C33X1123-60****+++
0.015	17.5	16.0	10.0	15.0	0.8	10 000	C33X1153-60****+++
0.018	17.5	19.0	11.0	15.0	0.8	10 000	C33X1183-60****+++
0.0022	26.5	15.0	6.0	22.5	0.8	6 000	C33X1222-90****+++
0.0027	26.5	15.0	6.0	22.5	0.8	6 000	C33X1272-90****+++
0.0033	26.5	15.0	6.0	22.5	0.8	6 000	C33X1332-90****+++
0.0039	26.5	15.0	6.0	22.5	0.8	6 000	C33X1392-90****+++
0.0047	26.5	15.0	6.0	22.5	0.8	6 000	C33X1472-90****+++
0.0056	26.5	15.0	6.0	22.5	0.8	6 000	C33X1562-90****+++
0.0068	26.5	15.0	6.0	22.5	0.8	6 000	C33X1682-90****+++
0.0082	26.5	15.0	6.0	22.5	0.8	6 000	C33X1822-90****+++
0.010	26.5	16.0	7.0	22.5	0.8	6 000	C33X1103-90****+++
0.012	26.5	16.0	7.0	22.5	0.8	6 000	C33X1123-90****+++
0.015	26.5	17.0	8.5	22.5	0.8	6 000	C33X1153-90****+++
0.018	26.5	18.5	10.0	22.5	0.8	6 000	C33X1183-90****+++
0.022	26.5	18.5	10.0	22.5	0.8	6 000	C33X1223-90****+++
0.027	26.5	22.0	12.0	22.5	0.8	6 000	C33X1273-90****+++
0.033	26.5	22.0	12.0	22.5	0.8	6 000	C33X1333-90****+++

- Note: 1. “-”=capacitance tolerance code, K=±10%,J=±5%,H=±3%
 2. “****”=lead form and packing code (refer to table 1)

■ Max voltage(Vr.m.s)versus frequency

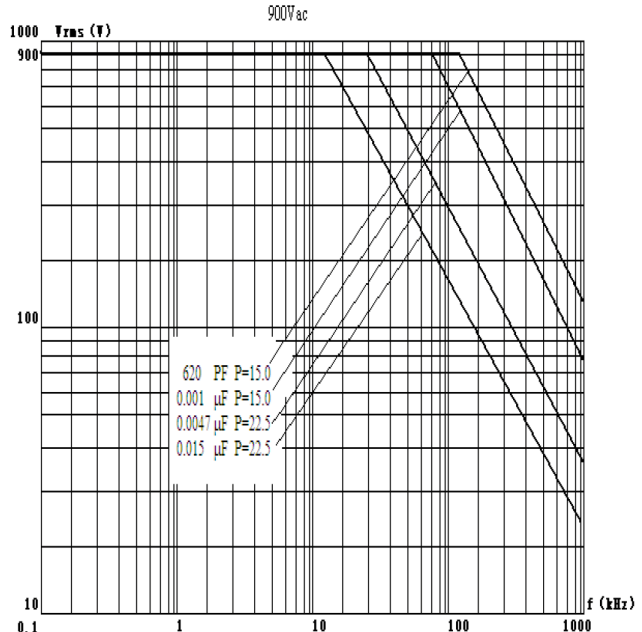
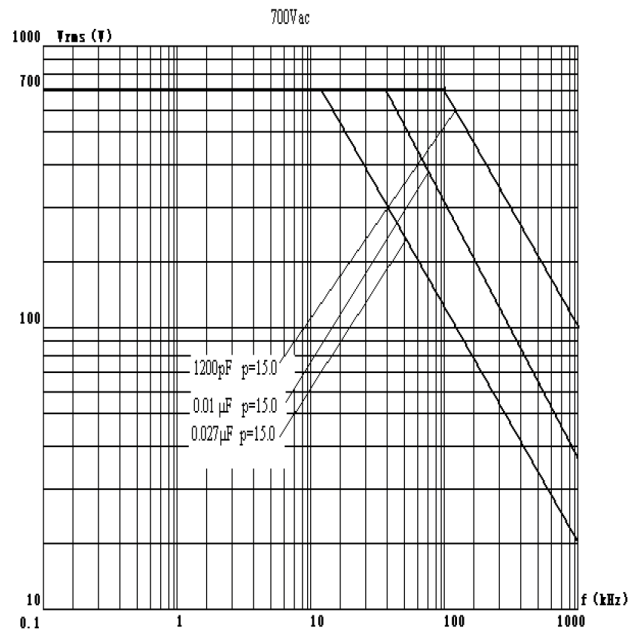
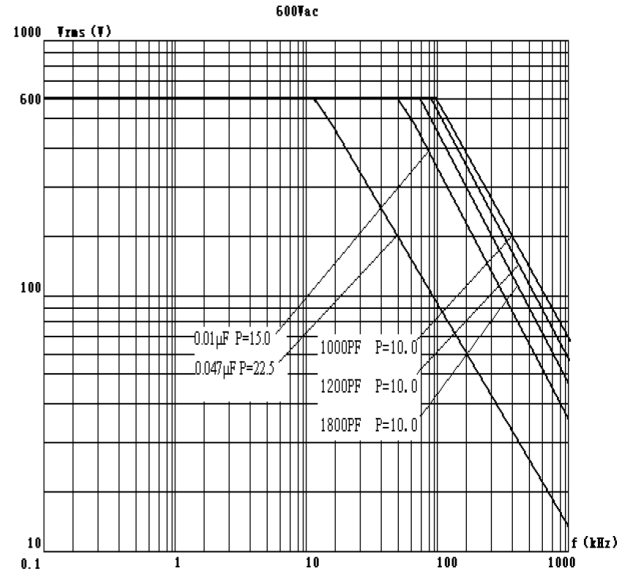
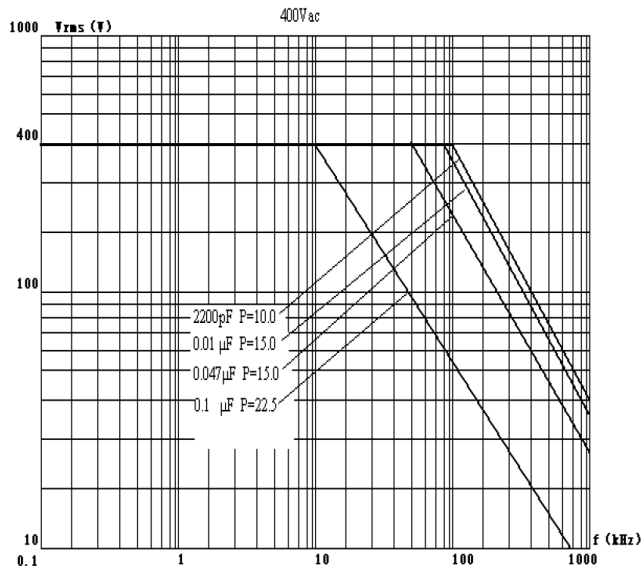

Note: sinusoidal wave-form, environment temperature $\leq 85^{\circ}\text{C}$, internal temperature rise $\Delta T=10^{\circ}\text{C}$, p (pitch) in mm..

■ Max current(Ir.m.s)versus frequency

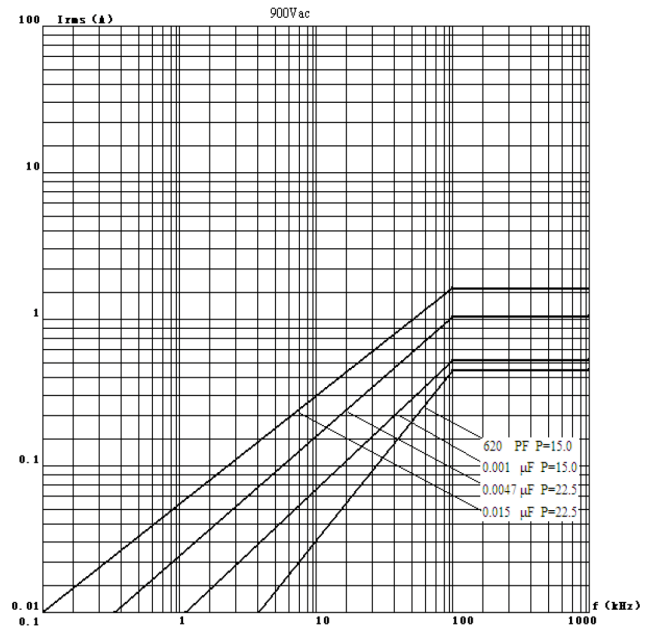
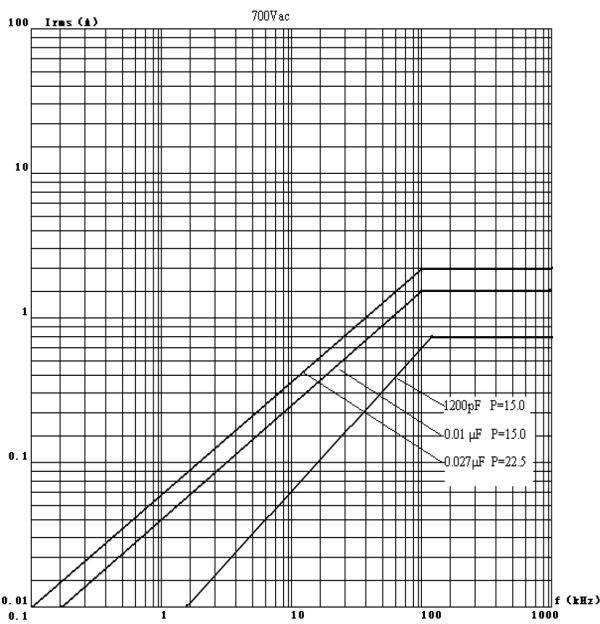
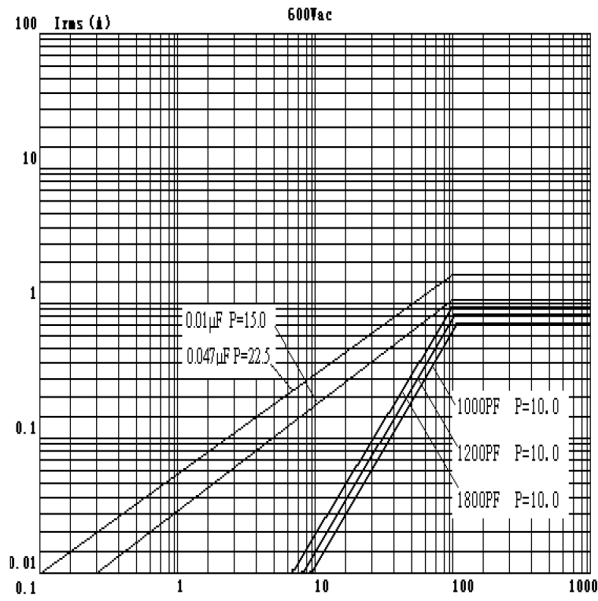
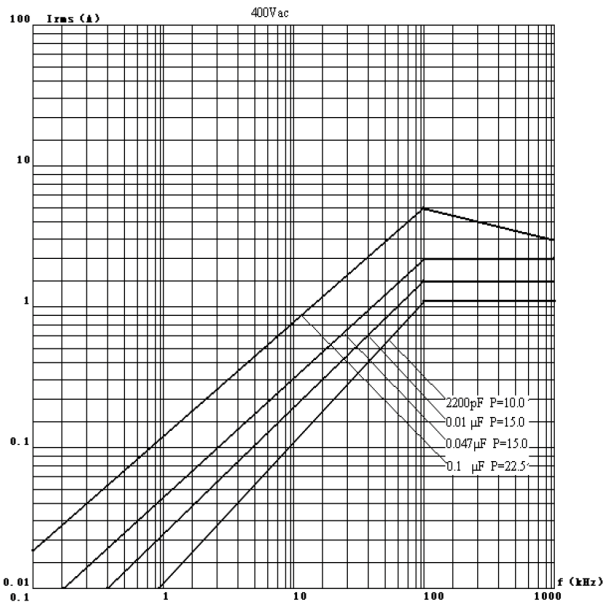

Note: sinusoidal wave-form, environment temperature $\leq 85^{\circ}\text{C}$, internal temperature rise $\Delta T=10^{\circ}\text{C}$, p (pitch) in mm.

■ Test Method And Performance

No.	Item	Performance	Test method(IEC 60384-17)
1	Solderability	Good quality of tinning	Solder temperature: 245°C ±5°C Immersion time: 2.0s±0.5s
2	Initial measurement	Capacitance Tgδ: 1kHz, C>1.0μF 10kHz, C≤1.0μF	
	Terminal strength	There shall be no visible damage	Tense: 0.50<d≤0.80, 10N 0.80<d≤1.25, 20N Bend: 0.50<d≤0.80, 5N 0.80<d≤1.25, 10N The terminals shall be bent 2 times in each direction
	Resistance to solder heat	There shall be no visible damage, legible marking	Solder temperature:260°C±5°C Immersion time: 10s±1s
	Final measurement	ΔC/C ≤±3%(relative to the initial value) Increase of tgδ: ≤0.004 (10kHz,C≤1.0μF) ≤0.004 (1kHz, C>1.0μF)	
3	Initial measurement	Capacitance Tgδ: 1kHz, C>1.0μF 10kHz, C≤1.0μF	
	Rapid change of temperature	There shall be no evidence of deterioration.	θ _A =-55°C, θ _B =+125°C 5 cycles Duration: t=30min
	Vibration	There shall be no evidence of deterioration.	Amplitude 0.75mm or acceleration 98m/s ² (whichever is the smaller severity), f: 10Hz to 500Hz.Three directions, 2h foreach direction, total 6h.
	Bump	There shall be no evidence of deterioration.	4 000 times, Acceleration: 390m/s ² ,Pulse duration, 6ms
	Final measurement	There shall be no visible damage ΔC/C ≤±3%(relative to the initial value) Increase of tgδ: ≤0.004 (10kHz,C≤1.0μF) ≤0.004 (1kHz, C>1.0μF)	
4	climate sequence	Initial measurement	Capacitance Tgδ: 1kHz, C>1.0μF 10kHz, C≤1.0μF
		Dry heat	+125°C, 16h
		Damp heat,Cyclic	Test Db, Severity: b, the first cycle
		Cold	-55°C, 2h
		Low air pressure	There shall be no permanent breakdown,flashover or other harmful deformation when applying U _R at the last 1 minute. 15°C~35°C, 8.5kPa, 1h
		Damp heat, cyclic other	Applying U _R for 1 minute after 15 minutes the test finished . Test Db, Severity b, the other cycles,

No.	Item		Performance	Test method(IEC 60384-17)
4	climate sequence (continue)	Final measurement	There shall be no visible damage, legible marking $\Delta C/C \leq \pm 5\%$ (relative to the initial value) Increase of $\text{tg}\delta$: ≤ 0.005 (10kHz, $C \leq 1.0\mu\text{F}$) ≤ 0.005 (1kHz, $C > 1.0\mu\text{F}$) I.R.: $\geq 50\%$ of the rated value	
5	Damp heat steady state		There shall be no visible damage, legible marking $\Delta C/C \leq \pm 5\%$ (relative to the initial value) Increase of $\text{tg}\delta$: ≤ 0.002 (1kHz) I.R.: $\geq 50\%$ of the rated value	Temperature: $40^\circ\text{C} \pm 2^\circ\text{C}$ Humidity: $93 \pm 3\%$ RH Duration: 56 days
6	Endurance		There shall be no visible damage, legible marking $\Delta C/C \leq \pm 5\%$ (relative to the initial value) Increase of $\text{tg}\delta$: ≤ 0.0015 (10kHz, $C \leq 1.0\mu\text{F}$) ≤ 0.0015 (1kHz, $C > 1.0\mu\text{F}$) I.R.: $\geq 50\%$ of the rated value	$T \leq 110^\circ\text{C}$, 2 000h, $1.25 \times U_C$ at 50Hz; $110^\circ\text{C} < T \leq 125^\circ\text{C}$, 1 000h, $1.25 \times U_C$ at 50Hz
7	Charging and discharging		$\Delta C/C \leq \pm 5\%$ (relative to the initial value) Increase of $\text{tg}\delta$: ≤ 0.005 (10kHz, $C \leq 1.0\mu\text{F}$) ≤ 0.005 (1kHz, $C > 1.0\mu\text{F}$) I.R.: $\geq 50\%$ of the rated value	Times: 10 000 Duration of charging: 0.5s Duration of discharging: 0.5s Charging voltage: rated voltage U_R Charging resistance: $220/C_N(\Omega)$ Discharging resistance: $U_R \div C_N \div dv/dt(\Omega)$ C_N : rated capacitance (μF) dv/dt value: see dimensions table

Quality ensuring test (before shipment):

Inspection item (each batch)	Inspection level (GB 2828)	
	IL	AQL
Appearance inspection	II	1.5%
Dimensions		
Capacitance	II	0.65%
Tangent of the loss angle		
Dielectric strength		
Insulation resistance		
Solderability	S-3	2.5%

■ Marking:

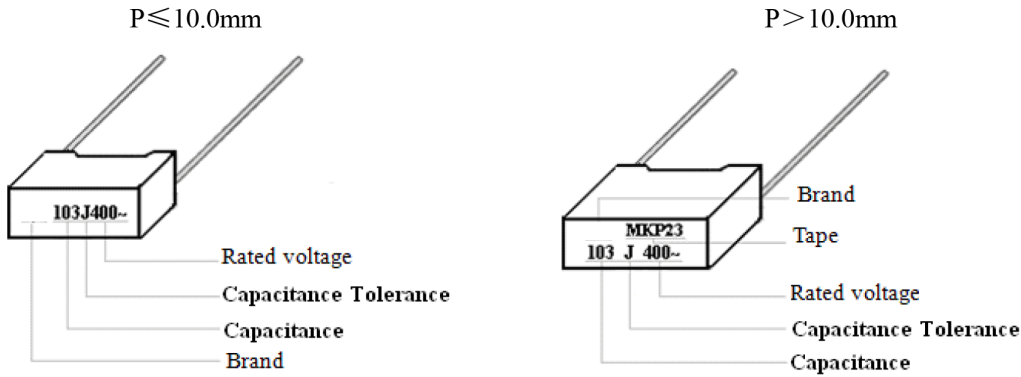

■ Taping specification for box-type capacitors

▲ Outline Drawing

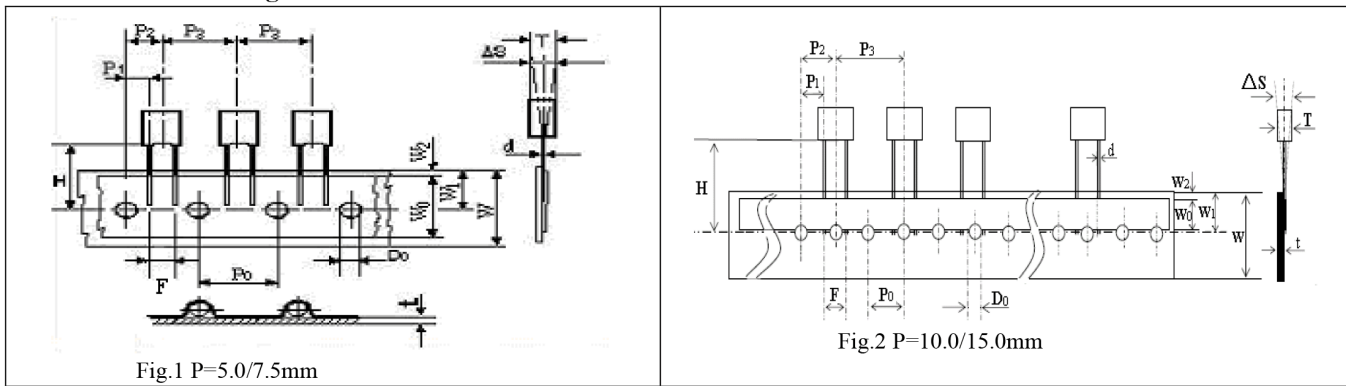

▲ Taping Dimensions(mm)

Technology index title	Code	Dimensions				Tolerance
		P=5.0	P=7.5	P=10.0	P=15.0	
Taping type	—	Fig 1	Fig 1	Fig2	Fig 2	—
Part number Digit12-15	Ammo-pack	A201	A301	A405	A605	
Taping pitch	P ₃	12.7	12.7	25.4	25.4	±1.0
Feed hole pitch	P ₀	12.7	12.7	12.7	12.7	±0.3
Center of wire	P ₁	3.85	2.6	7.7	5.2	±0.7
Center of body	P ₂	6.35	6.35	12.7	12.7	±1.3
Pitch of taping wire	F**	5.0	7.5	10.0	15.0	+0.6 -0.1
Component alignment	ΔS	0	0	0	0	±2.0
Height of component from tape center	H***	18.5	18.5	18.5	18.5	±0.5
Carrier tape width	W	18.0	18.0	18.0	18.0	+1.0 -0.5
Hold down tape width	W ₀	6min	10min	10min	10min	—
Hole position	W ₁	9.0	9.0	9.0	9.0	±0.5
Hold down tape position	W ₂	3max	3max	3max	3max	—
Feed hole dia.	D ₀	4.0	4.0	4.0	4.0	±0.2
Tape thickness	t	0.7	0.7	0.7	0.7	±0.2

▲ Packing Quantity

Pitch (mm)	Box thickness T(mm)	Ammo-pack (pcs/box)	
		Domestic	Export
5.0	2.5	2500	2 000
	3.5	1 700	1 500
	4.5	1 400	1 300
	5.0	1 200	1 000
7.5	6.0	1 000	800
	3.5	1 700	1 500
	4.0	1 500	1 350
	5.0	1 200	1 050
10.0/ 15.0	6.0	1 000	850
	4.0	750	650
	5.0	600	500
15.0	6.0	500	450
	7.5	400	350
	8.5	350	300
	10.0	300	250
	11.0	250	220

Note: * P₀=15mm is also available;
 **F can be other lead spacing;
 ***H=16.5mm is available;

■ Packing box sizes(mm)

1. Out packing box for bulk

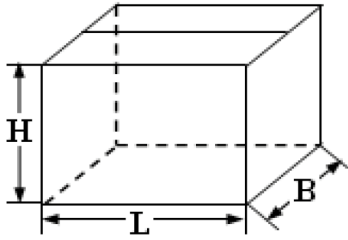

L:375±5
B:375±5
H:265±5

2. Inner packing box for bulk

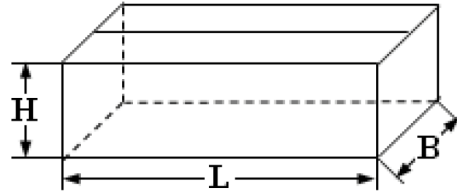

L:355±3
B:175±3
H:118±3

3. Box sizes for Ammo-pack

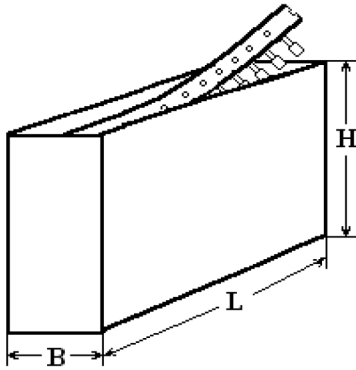

L:330±3
B:48±3
H:260±3