

FEATURES

- ※ Sealed
- ※ Snap in type
- ※ Dust proof with high reliability

APPLICATION

- ※ Audio, OA equipment
- ※ Instrumentation, Communication
- ※ White goods

SPECIFICATION

Contact Rating	50mA, 12V DC
Contact Resistance	100mΩ max.
Insulation Resistance	100MΩ min. 500V DC
Dielectric Strength	250V AC/1 minute
Operating Force	160±50gf, Brown(N) 66/677 160±50gf, Silver(S) 68 180±50gf, Brown(N) 69/67/65/64 260±70gf, Red(R) 69/67/66/65/64 360±90gf, Transparent(T) 69/67/65/677
Travel	0.25mm 68S/66N/66R/677 0.45mm(69/67N,R)/(65/64N,R,T) 0.6mm 69/67T
Operating Life	100,000 cycles min. for 66/68/677 500,000 cycles min. for 69/67/65/64
Operating Temp.	-25°C ~ +70°C
Storage Temp.	-30°C ~ +80°C

HOW TO ORDER

SDTSHW - 6 □ □ - □ - **B**

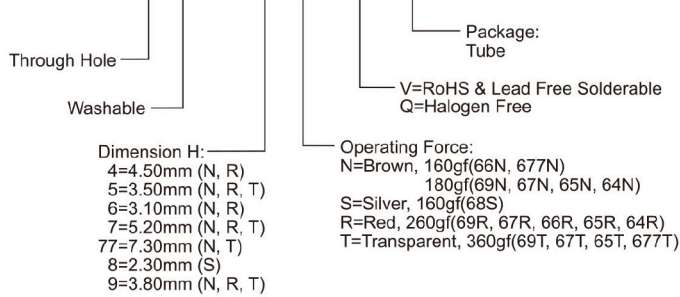

CIRCUIT

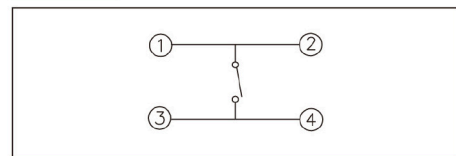

PACKAGE

<Tube>
75 pcs

TACT SWITCH

SDTSHW-66

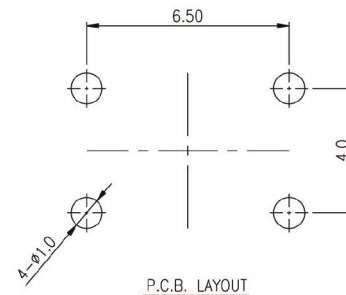
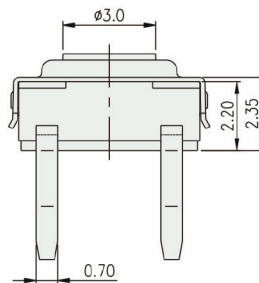
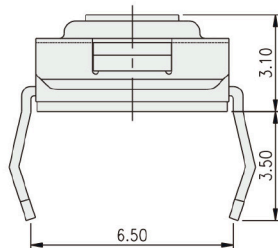
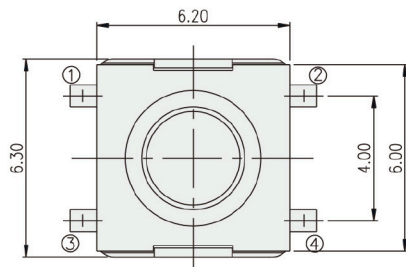

TACT SWITCH
SDTSHW-6 SERIES

6x6 Through Hole
 Washable Type



SDTSHW-68

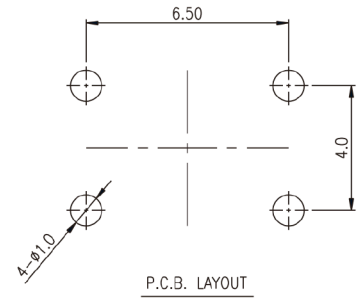
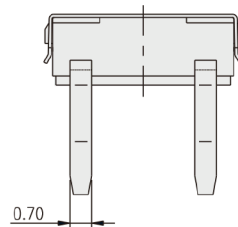
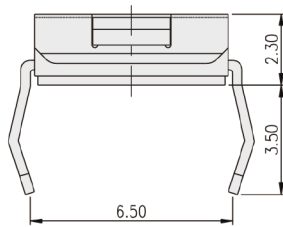
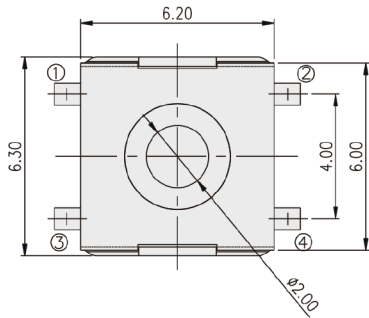

TACT SWITCH

SDTSHW-6

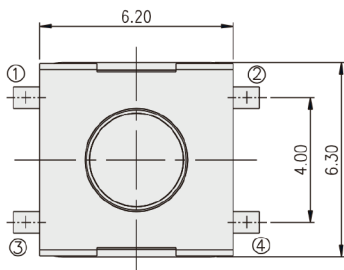

PART NO.	H
SDTSHW-64	4.50
SDTSHW-65	3.50
SDTSHW-67	5.20
SDTSHW-69	3.80
SDTSHW-677	7.30

