

P-Channel Enhancement Mode MOSFET

Features

- Surface-mounted package
- Low Gate-Source Threshold Voltage
- Halogen and Antimony Free(HAF), RoHS compliant

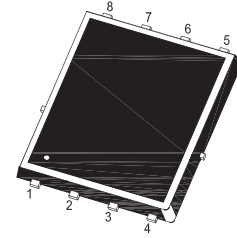
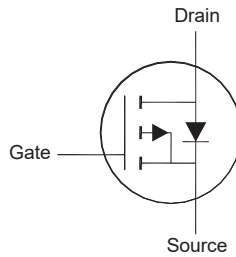

1.Source 2.Source 3.Source 4.Gate
5.Drain 6.Drain 7.Drain 8.Drain
DFN5060 Plastic Package

Key Parameters

Parameter	Value	Unit
$-V_{(BR)DSS}$	40	V
$R_{DS(ON) Max}$	86 @ $-V_{GS} = 10 V$	m Ω
	134 @ $-V_{GS} = 4.5 V$	
$-V_{GS(th) typ}$	1.7	V
$Q_g typ$	8.5 @ $-V_{GS} = 10 V$	nC

Absolute Maximum Ratings (at $T_a = 25^\circ C$ unless otherwise specified)

Parameter	Symbol	Value	Unit
Drain-Source Voltage	$-V_{DS}$	40	V
Gate-Source Voltage	V_{GS}	± 20	V
Drain Current	$-I_D$	$T_c = 25^\circ C$ 5.5 $T_c = 100^\circ C$	A
Peak Drain Current, Pulsed ¹⁾	$-I_{DM}$	25	A
Single Pulse Avalanche Current	$-I_{AS}$	9.1	A
Single Pulse Avalanche Energy ²⁾	E_{AS}	4.1	mJ
Total Power Dissipation	P_{tot}	12.1	W
Operating Junction and Storage Temperature Range	T_J, T_{stg}	- 55 to + 150	$^\circ C$

Thermal Characteristics

Parameter	Symbol	Max.	Unit
Thermal Resistance from Junction to Case	$R_{\theta JC}$	10.2	$^\circ C/W$
Thermal Resistance from Junction to Ambient ³⁾	$R_{\theta JA}$	50	$^\circ C/W$

¹⁾ Pulse Test: Pulse Width $\leq 100 \mu s$, Duty Cycle $\leq 2\%$, Repetitive rating, pulse width limited by junction temperature $T_{J(MAX)} = 150^\circ C$.

²⁾ Limited by $T_{J(MAX)}$, starting $T_J = 25^\circ C$, $L = 0.1 mH$, $R_g = 25 \Omega$, $-I_{AS} = 9.1 A$, $V_{GS} = 10 V$.

³⁾ Device mounted on FR-4 substrate PC board, 2oz copper, with 1-inch square copper plate in still air.

Characteristics at $T_a = 25^\circ\text{C}$ unless otherwise specified

Parameter	Symbol	Min.	Typ.	Max.	Unit
STATIC PARAMETERS					
Drain-Source Breakdown Voltage at $-I_D = 250 \mu\text{A}$	$-V_{(BR)DSS}$	40	-	-	V
Drain-Source On-State Current at $-V_{DS} = 40 \text{ V}$	$-I_{DSS}$	-	-	1	μA
Gate-Source Leakage Current at $V_{GS} = \pm 20 \text{ V}$	I_{GSS}	-	-	± 100	nA
Gate-Source Threshold Voltage at $V_{DS} = V_{GS}$, $-I_D = 250 \mu\text{A}$	$-V_{GS(th)}$	1.2	-	2.5	V
Drain-Source On-State Resistance at $-V_{GS} = 10 \text{ V}$, $-I_D = 8 \text{ A}$ at $-V_{GS} = 4.5 \text{ V}$, $-I_D = 6 \text{ A}$	$R_{DS(ON)}$	-	73	86 134	m Ω
DYNAMIC PARAMETERS					
Forward Transconductance at $-V_{DS} = 5 \text{ V}$, $-I_D = 6 \text{ A}$	g_{fs}	-	7	-	S
Gate Resistance at $V_{GS} = 0 \text{ V}$, $V_{DS} = 0 \text{ V}$, $f = 1 \text{ MHz}$	R_g	-	6.8	-	Ω
Input Capacitance at $V_{GS} = 0 \text{ V}$, $-V_{DS} = 20 \text{ V}$, $f = 1 \text{ MHz}$	C_{iss}	-	446	-	pF
Output Capacitance at $V_{GS} = 0 \text{ V}$, $-V_{DS} = 20 \text{ V}$, $f = 1 \text{ MHz}$	C_{oss}	-	39	-	pF
Reverse Transfer Capacitance at $V_{GS} = 0 \text{ V}$, $-V_{DS} = 20 \text{ V}$, $f = 1 \text{ MHz}$	C_{rss}	-	33	-	pF
Total Gate Charge at $-V_{GS} = 10 \text{ V}$, $-V_{DS} = 20 \text{ V}$, $-I_D = 8 \text{ A}$ at $-V_{GS} = 4.5 \text{ V}$, $-V_{DS} = 20 \text{ V}$, $-I_D = 8 \text{ A}$	Q_g	-	8.5 3.7	-	nC
Gate-Source Charge at $-V_{GS} = 10 \text{ V}$, $-V_{DS} = 20 \text{ V}$, $-I_D = 8 \text{ A}$	Q_{gs}	-	2.3	-	nC
Gate-Drain Charge at $-V_{GS} = 10 \text{ V}$, $-V_{DS} = 20 \text{ V}$, $-I_D = 8 \text{ A}$	Q_{gd}	-	1.3	-	nC
Turn-On Delay Time at $-V_{GS} = 10 \text{ V}$, $-V_{DS} = 20 \text{ V}$, $-I_D = 8 \text{ A}$, $R_g = 3.3 \Omega$	$t_{d(on)}$	-	6.5	-	ns
Turn-On Rise Time at $-V_{GS} = 10 \text{ V}$, $-V_{DS} = 20 \text{ V}$, $-I_D = 8 \text{ A}$, $R_g = 3.3 \Omega$	t_r	-	18	-	ns
Turn-Off Delay Time at $-V_{GS} = 10 \text{ V}$, $-V_{DS} = 20 \text{ V}$, $-I_D = 8 \text{ A}$, $R_g = 3.3 \Omega$	$t_{d(off)}$	-	7	-	ns
Turn-Off Fall Time at $-V_{GS} = 10 \text{ V}$, $-V_{DS} = 20 \text{ V}$, $-I_D = 8 \text{ A}$, $R_g = 3.3 \Omega$	t_f	-	1.8	-	ns
Body-Diode PARAMETERS					
Drain-Source Diode Forward Voltage at $-I_S = 1 \text{ A}$, $V_{GS} = 0 \text{ V}$	$-V_{SD}$	-	-	1.2	V
Body-Diode Continuous Current	$-I_S$	-	-	8.8	A
Body-Diode Continuous Current, Pulsed	$-I_{SM}$	-	-	25	A
Body Diode Reverse Recovery Time at $-I_S = 8 \text{ A}$, $di/dt = 100 \text{ A} / \mu\text{s}$	t_{rr}	-	9.1	-	ns
Body Diode Reverse Recovery Charge at $-I_S = 8 \text{ A}$, $di/dt = 100 \text{ A} / \mu\text{s}$	Q_{rr}	-	4.3	-	nC

Electrical Characteristics Curves

Fig. 1 Typical Output Characteristics

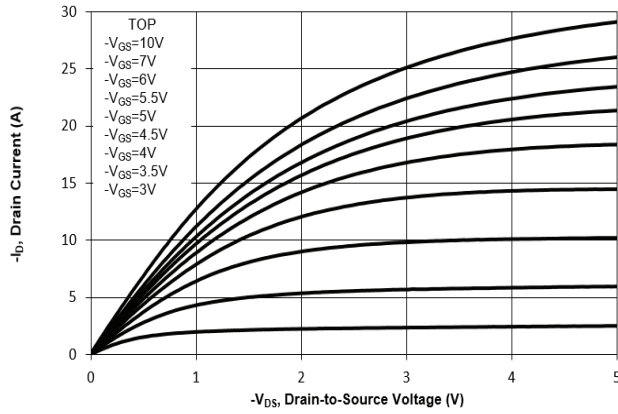

Fig. 2 Typical Transfer Characteristics

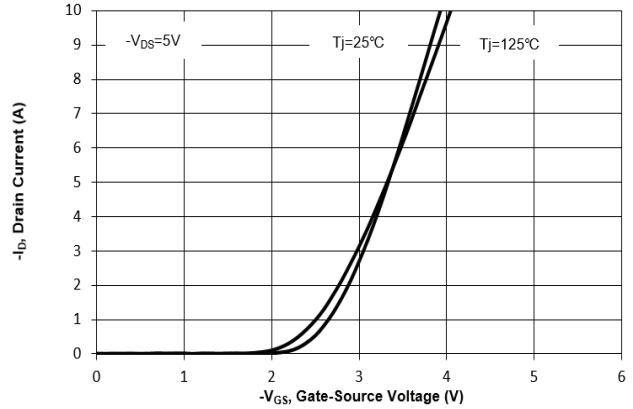

Fig. 3 on-Resistance vs. Drain Current

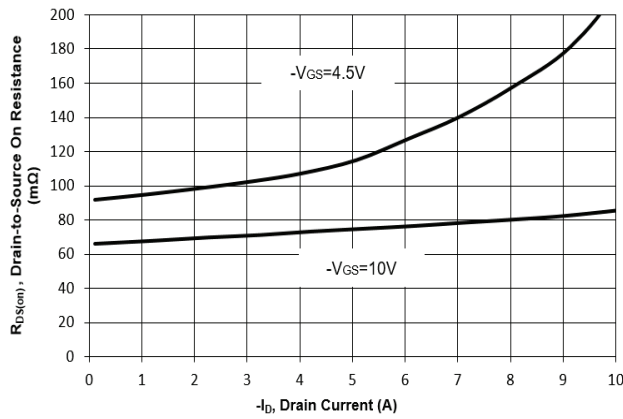

Fig. 4 on-Resistance vs. Gate to Source Voltage

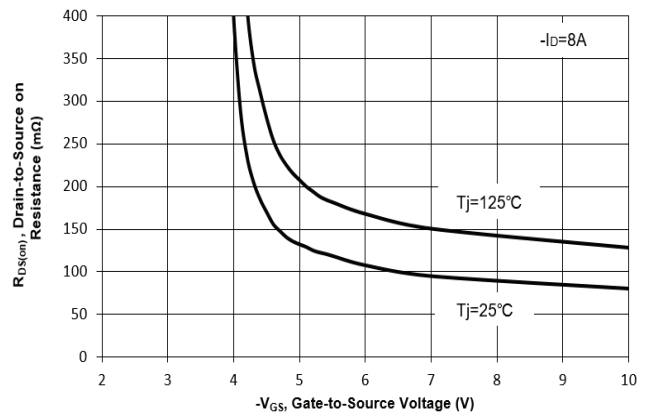

Fig. 5 on-Resistance vs. Tj

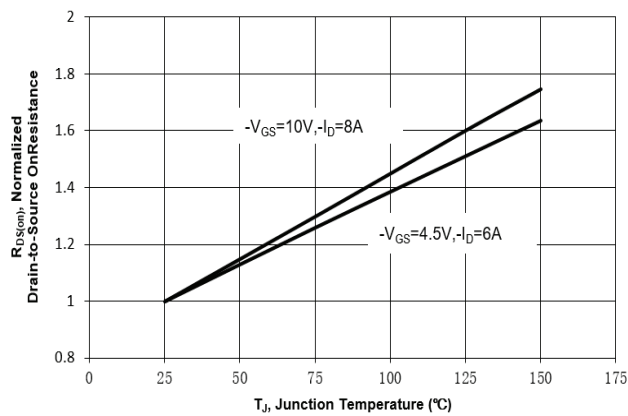
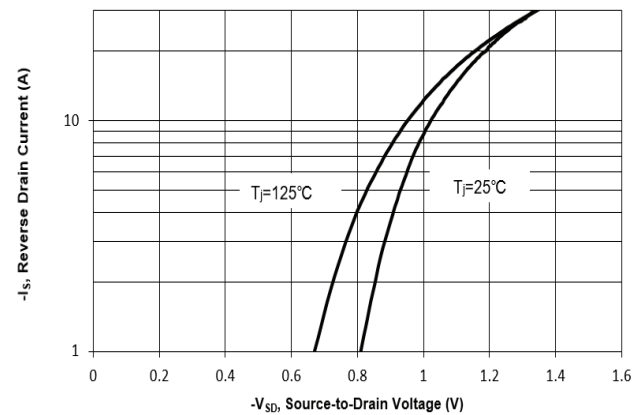

Fig. 6 Typical Body-Diode Forward Characteristics



Electrical Characteristics Curves

Fig. 7 Typical Junction Capacitance

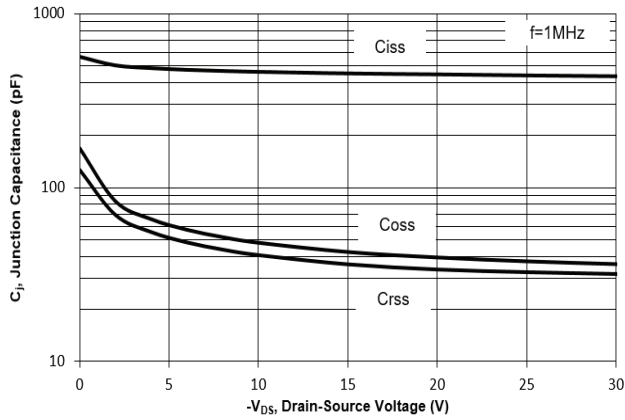

Fig. 8 Drain-Source Leakage Current vs. T_J

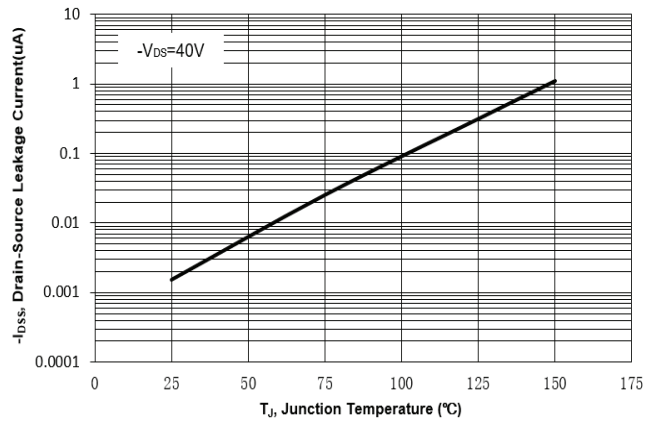

Fig. 9 V_{(BR)DSS} vs. Junction Temperature

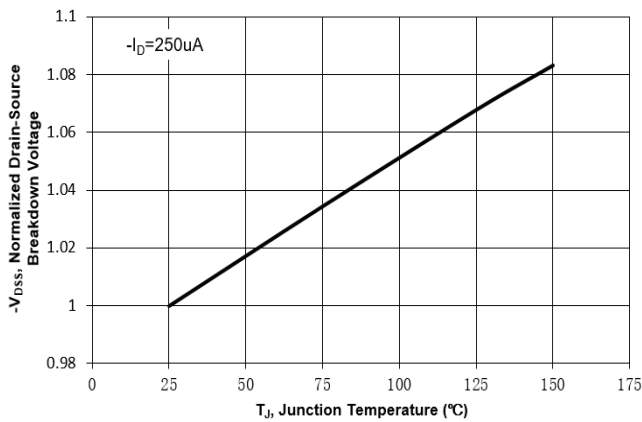

Fig. 10 Gate-Source Threshold Voltage vs. T_J

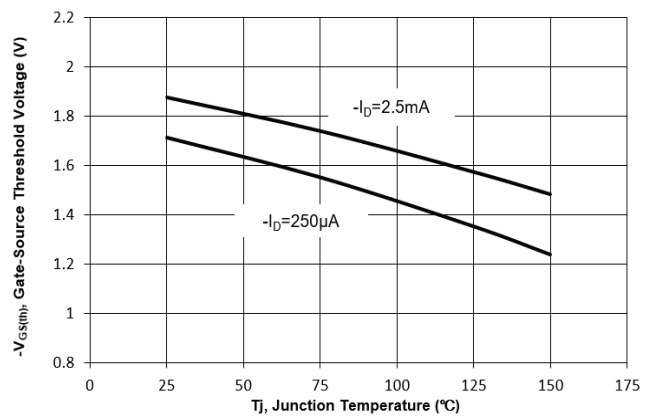

Fig. 11 Gate Charge

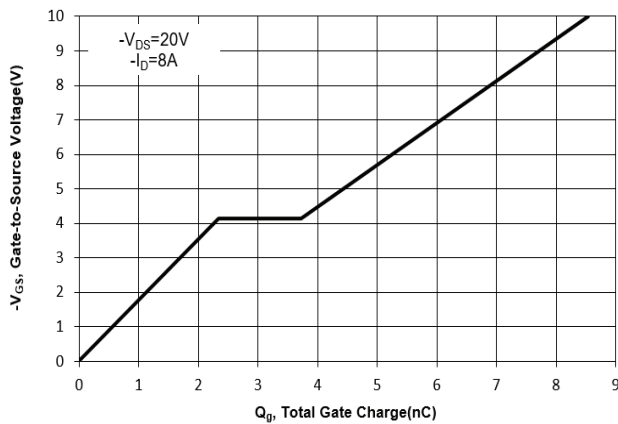
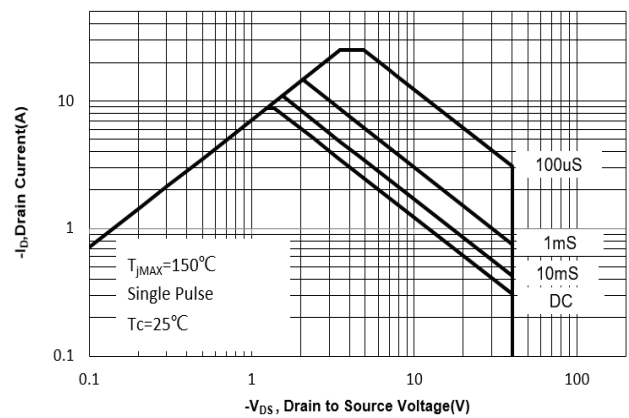

Fig. 12 Safe Operation Area



Electrical Characteristics Curves

Fig. 13 Normalized Maximum Transient Thermal Impedance($Z_{\theta JC}$)

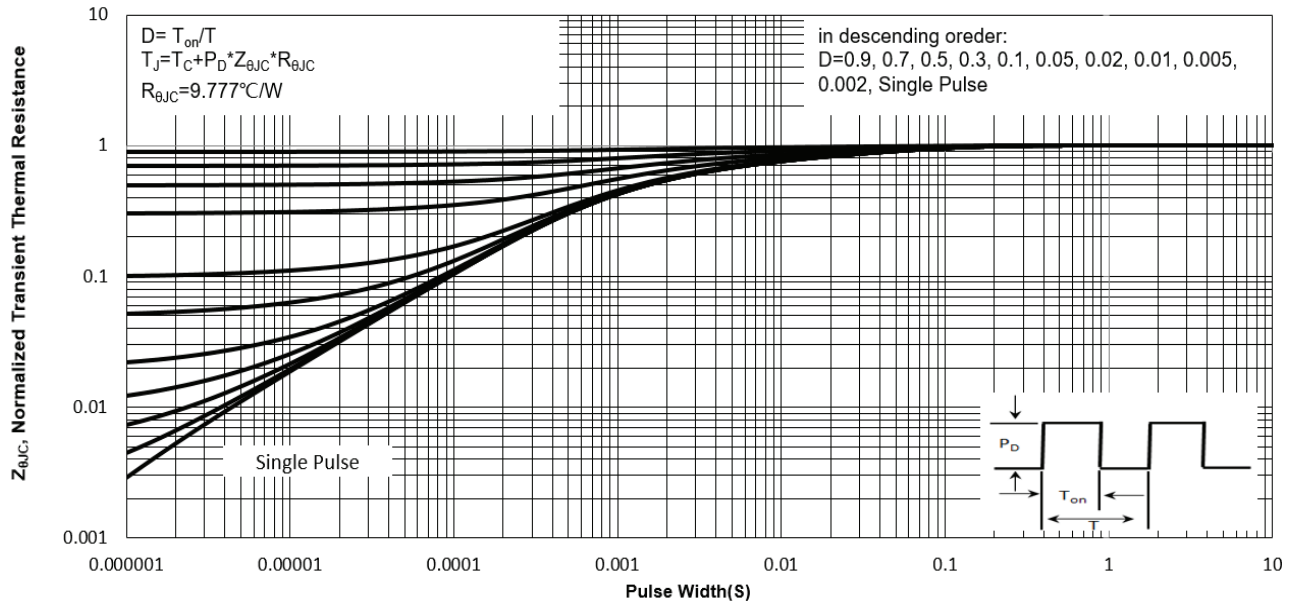
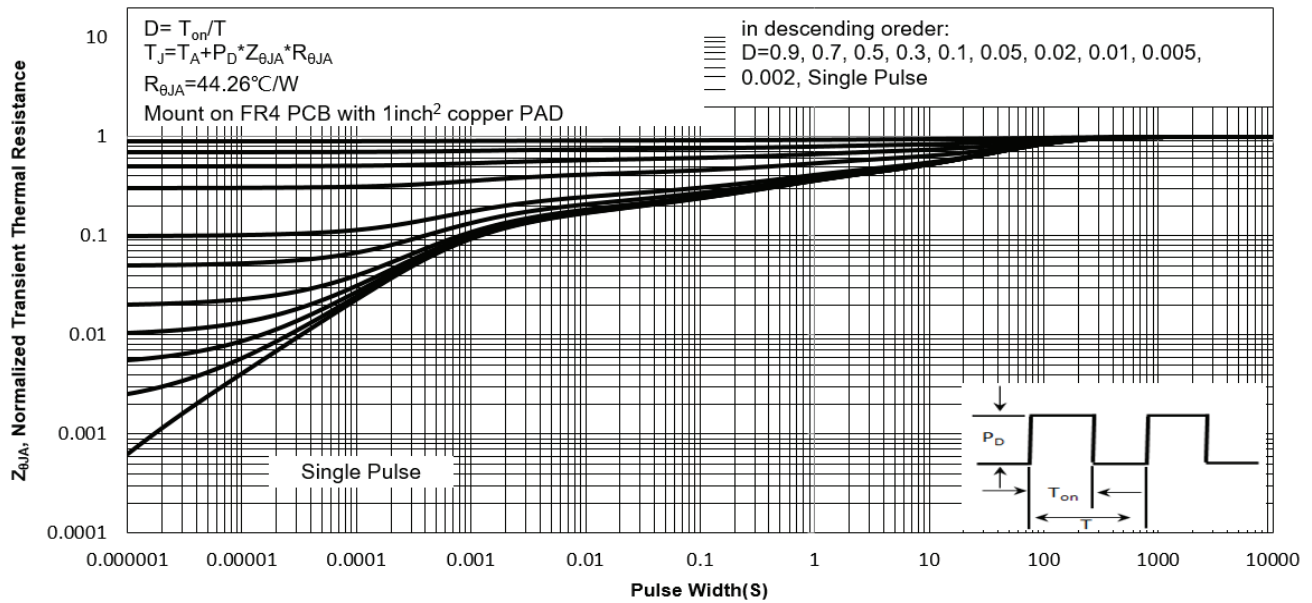
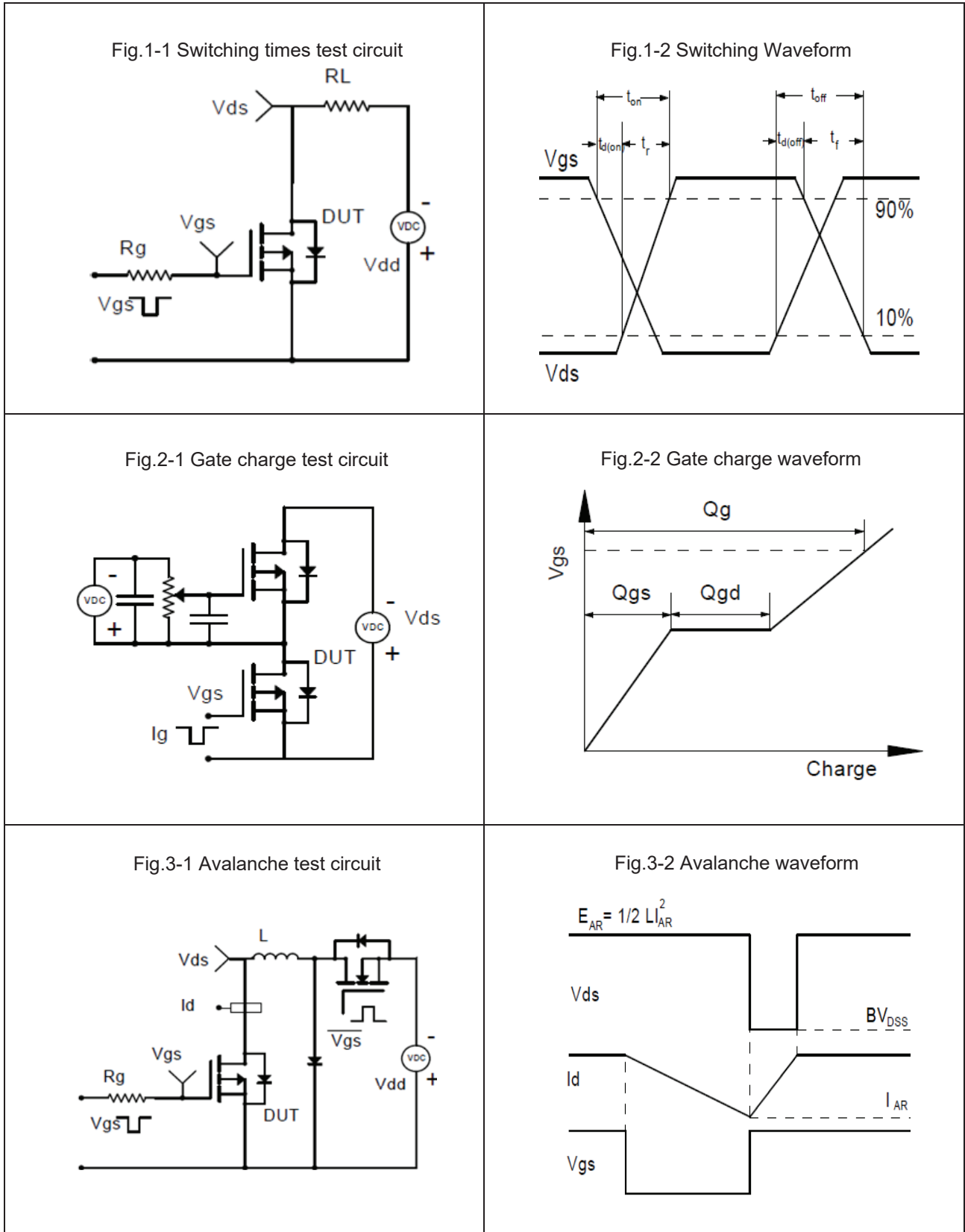

Fig. 14 Normalized Maximum Transient Thermal Impedance($Z_{\theta JA}$)



Test Circuits



Package Outline Dimensions (Units: mm)

DFN5060

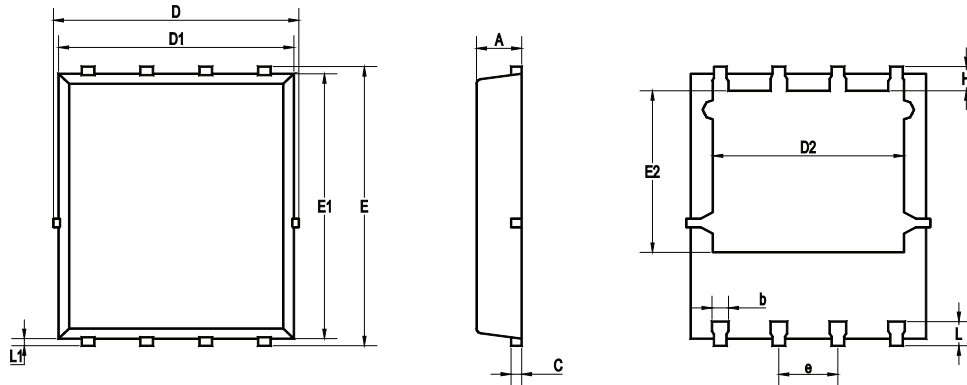

UNIT	A	b	C	D	D1	D2	E	E1	E2	e	L	L1	H
mm	1.12	0.51	0.34	5.26	5.1	4.5	6.25	6	3.66	1.37	0.71	0.2	0.71
	0.9	0.33	0.11	4.7	4.7	3.56	5.75	5.6	3.18	1.17	0.35	0.06	0.35

Recommended Soldering Footprint

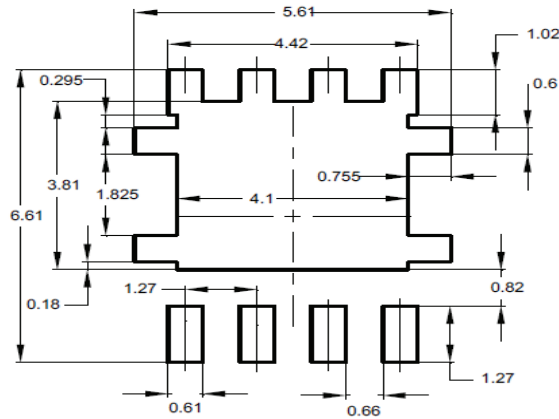

Packing information

Package	Tape Width (mm)	Pitch		Reel Size		Per Reel Packing Quantity
		mm	inch	mm	inch	
DFN5060	12	8 ± 0.1	0.315 ± 0.004	330	13	5,000

Marking information

" TM504P700LS " = Part No.
 " ***** " = Date Code Marking
 Font type: Arial

