

DIP SWITCH

SE(M)(I)(S)(J) SERIES

End Stackable / SMT & Through Hole Type



2018

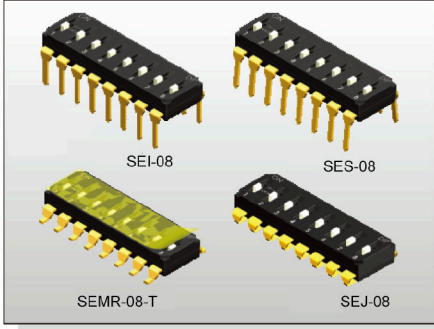

FEATURES

- ※ End stackable
- ※ Through hole or SMT
- ※ Gold contact provides high reliability

APPLICATION

- ※ Industrial control
- ※ Automatic machines control
- ※ Telecommunication

SPECIFICATION

Contact Rating	25mA, 24V DC
Contact Resistance	100mΩ max.
Insulation Resistance	100MΩ min. 500V DC
Dielectric Strength	500V AC/1 minute
Operating Force	1,000gf max.
Travel	1mm
Operating Life	2,000 cycles
Operating Temp.	-20°C ~ +85°C
Storage Temp.	-40°C ~ +85°C

HOW TO ORDER

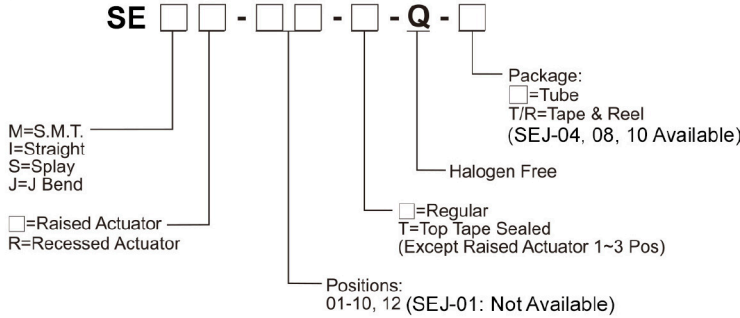

CIRCUIT

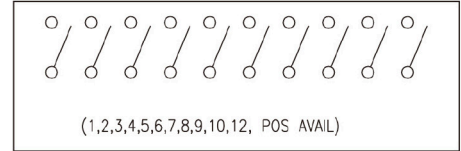

PACKAGE

- <Tube>  
 SEM(R)/SEI(R)/SES(R)-01: 194 pcs  
 SE□(R)-02: 95 pcs  
 SE□(R)-03: 63 pcs  
 SE□(R)-04: 47 pcs  
 SE□(R)-05: 38 pcs  
 SE□(R)-06: 31 pcs  
 SE□(R)-07: 27 pcs  
 SE□(R)-08: 23 pcs  
 SE□(R)-09: 21 pcs  
 SE□(R)-10: 19 pcs  
 SE□(R)-12: 15 pcs
- <Tape & Reel>  
 SEM(R)-01~10, 12: 900 pcs  
 SEJ(R)-04, 08, 10: 900 pcs

SEM(R)

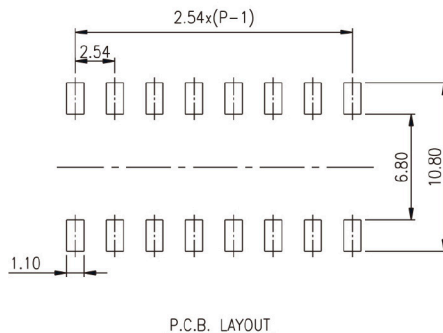
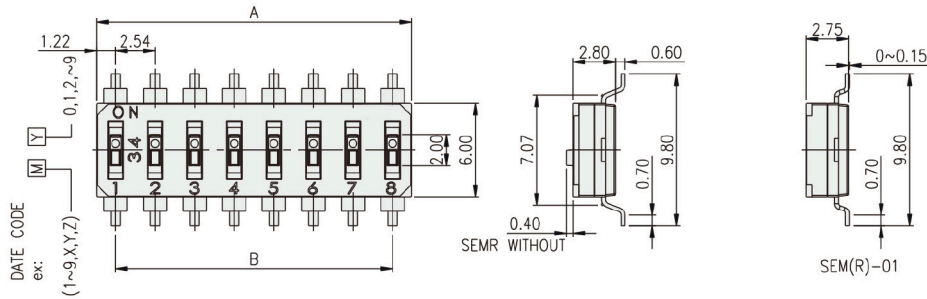

PART NO.	NO. OF POS.	DIM.A	DIM.B
SEM(R)-01	1	2.44	/
SEM(R)-02	2	4.98	2.54
SEM(R)-03	3	7.52	5.08
SEM(R)-04	4	10.06	7.62
SEM(R)-05	5	12.60	10.16
SEM(R)-06	6	15.14	12.70
SEM(R)-07	7	17.68	15.24
SEM(R)-08	8	20.22	17.78
SEM(R)-09	9	22.76	20.32
SEM(R)-10	10	25.30	22.86
SEM(R)-12	12	30.38	27.94

DIP SWITCH

SEI(R)

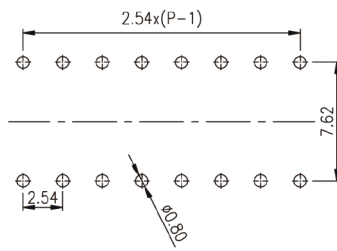
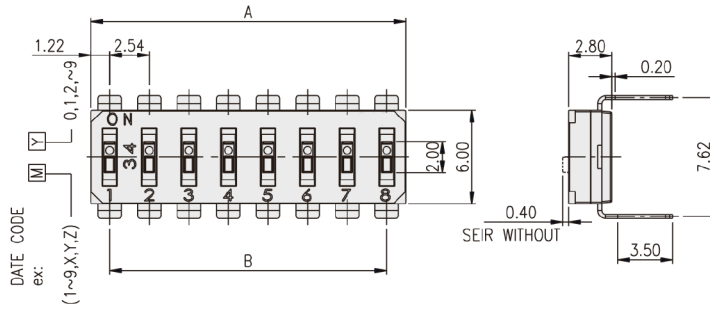

P.C.B. LAYOUT

PART NO.	NO.OF POS.	DIM.A	DIM.B
SEI(R)-01	1	2.44	/
SEI(R)-02	2	4.98	2.54
SEI(R)-03	3	7.52	5.08
SEI(R)-04	4	10.06	7.62
SEI(R)-05	5	12.60	10.16
SEI(R)-06	6	15.14	12.70
SEI(R)-07	7	17.68	15.24
SEI(R)-08	8	20.22	17.78
SEI(R)-09	9	22.76	20.32
SEI(R)-10	10	25.30	22.86
SEI(R)-12	12	30.38	27.94



DIP SWITCH

SES(R)

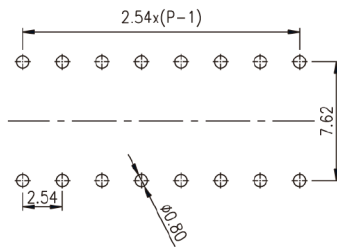
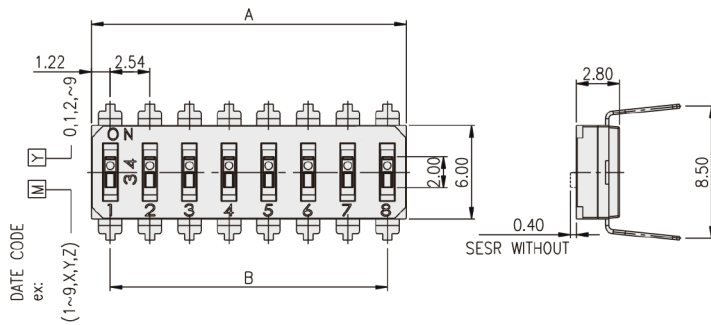

P.C.B. LAYOUT

PART NO.	NO.OF POS.	DIM.A	DIM.B
SES(R)-01	1	2.44	/
SES(R)-02	2	4.98	2.54
SES(R)-03	3	7.52	5.08
SES(R)-04	4	10.06	7.62
SES(R)-05	5	12.60	10.16
SES(R)-06	6	15.14	12.70
SES(R)-07	7	17.68	15.24
SES(R)-08	8	20.22	17.78
SES(R)-09	9	22.76	20.32
SES(R)-10	10	25.30	22.86
SES(R)-12	12	30.38	27.94

DIP SWITCH  
SE(M)(I)(S)(J) SERIES

End Stackable /  
SMT & Through Hole Type



SEJ(R)



DIP SWITCH

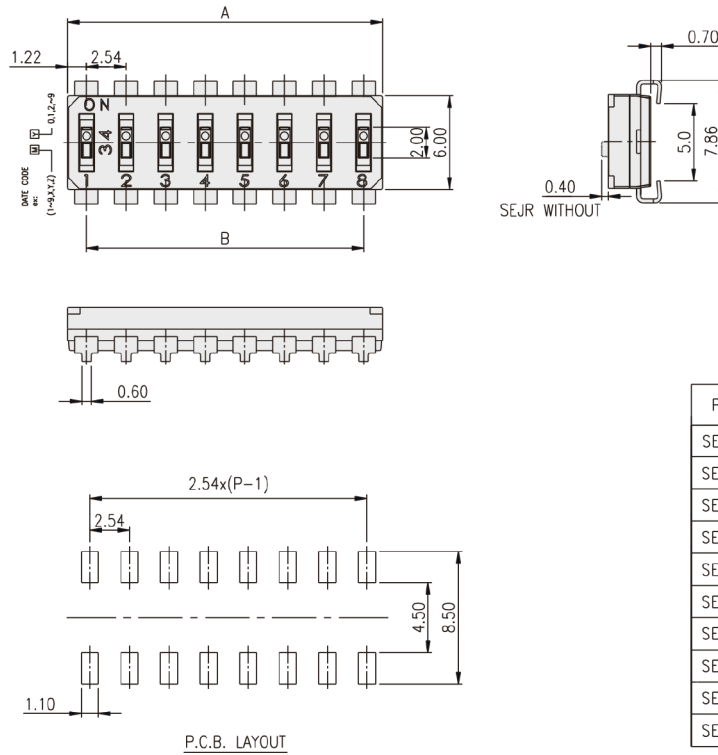

PART NO.	NO.OF POS.	DIM.A	DIM.B
SEJ(R)-02	2	4.98	2.54
SEJ(R)-03	3	7.52	5.08
SEJ(R)-04	4	10.06	7.62
SEJ(R)-05	5	12.60	10.16
SEJ(R)-06	6	15.14	12.70
SEJ(R)-07	7	17.68	15.24
SEJ(R)-08	8	20.22	17.78
SEJ(R)-09	9	22.76	20.32
SEJ(R)-10	10	25.30	22.86
SEJ(R)-12	12	30.38	27.94