

**FEATURES**

- ※ Side actuation
- ※ End stackable
- ※ Through hole or SMT

**APPLICATION**

- ※ Industrial control
- ※ Automatic machines control
- ※ Telecommunication

**SPECIFICATION**

Contact Rating	25mA, 24V DC
Contact Resistance	100mΩ max.
Insulation Resistance	100MΩ min. 500V DC
Dielectric Strength	500V AC/1 minute
Operating Force	800gf max.
Travel	1mm
Operating Life	2,000 cycles
Operating Temp.	-20°C ~ +85°C
Storage Temp.	-40°C ~ +85°C

**HOW TO ORDER**

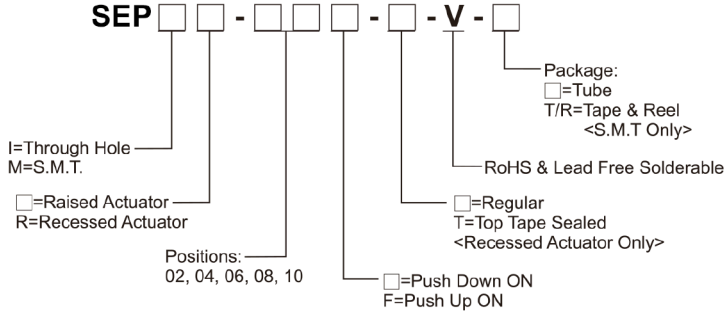

**CIRCUIT**

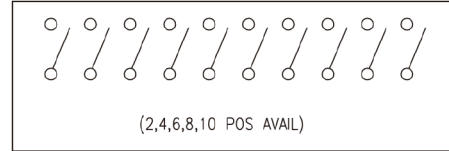

**PACKAGE**

- <Tube>  
SEP□(R)-02: 95 pcs  
SEP□(R)-04: 47 pcs  
SEP□(R)-06: 31 pcs  
SEP□(R)-08: 23 pcs  
SEP□(R)-10 18 pcs
- <Tape & Reel>  
SEPM(R): 700 pcs

DIP SWITCH

**SEPI(R)**

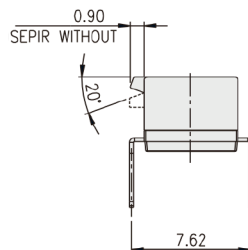
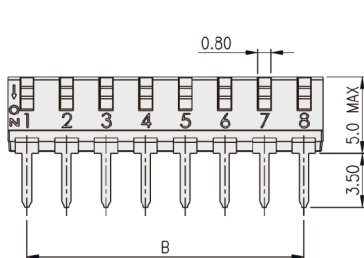
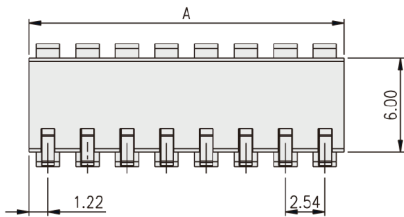

PART NO.	NO.OF POS.	DIM.A	DIM.B
SEPI(R)-02	2	4.98	2.54
SEPI(R)-04	4	10.06	7.62
SEPI(R)-06	6	15.14	12.70
SEPI(R)-08	8	20.22	17.78
SEPI(R)-10	10	25.30	22.86

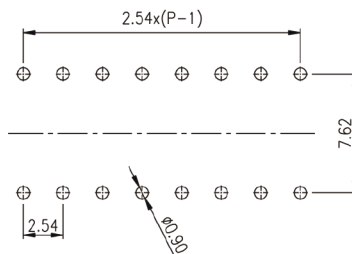

P.C.B. LAYOUT

DIP SWITCH  
SEP(I)(M) SERIES

End Stackable  
Piano Type



SEPM(R)

DIP SWITCH

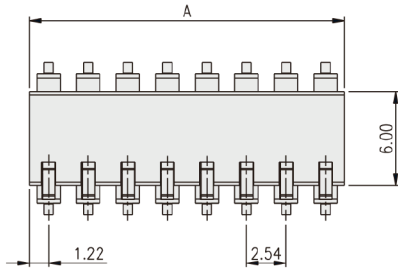

PART NO.	NO.OF POS.	DIM.A	DIM.B
SEPM(R)-02	2	4.89	2.54
SEPM(R)-04	4	10.06	7.62
SEPM(R)-06	6	15.14	12.70
SEPM(R)-08	8	20.22	17.78
SEPM(R)-10	10	25.30	22.86

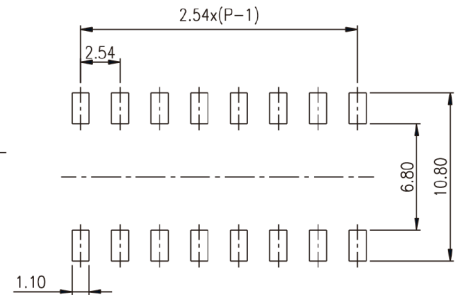
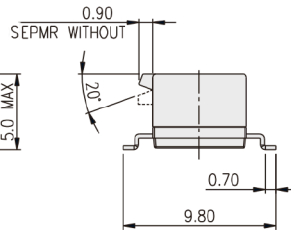
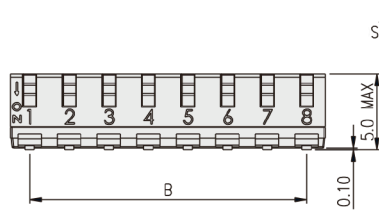

P.C.B. LAYOUT

SEPI(R)-F

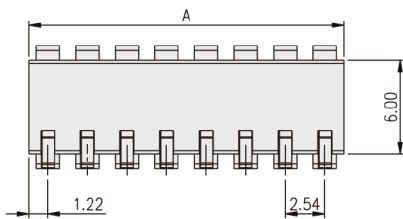

PART NO.	NO.OF POS.	DIM.A	DIM.B
SEPI(R)-02F	2	4.89	2.54
SEPI(R)-04F	4	10.06	7.62
SEPI(R)-06F	6	15.14	12.70
SEPI(R)-08F	8	20.22	17.78
SEPI(R)-10F	10	25.30	22.86

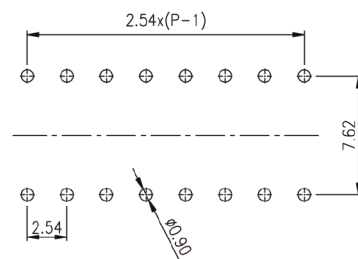
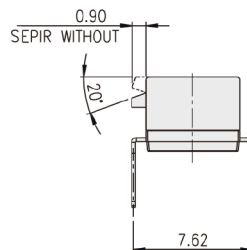
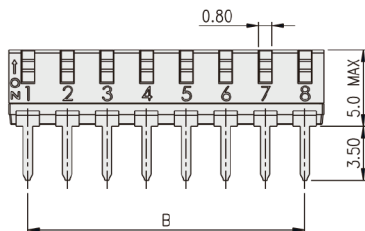

P.C.B. LAYOUT