



SPECIFICATION FOR APPROVAL

File No.: Q/FRK 0.GS.E.C32-D08

Product Name	Metallized polypropylene film capacitor (Box-type)
Product Type	C32(MKP21 Series)
Product Code	
Customer	
Customer Code	
Issue Date	2015-8

SURGE COMPONENTS, INC.
95 E. JEF RYN BLVD.,
DEER PARK, NY 11729
TEL: 631-595-1818
WWW.SURGECOMPONENTS.COM

Revision record

No.	Revision description	Recorder	Date	Revised version

Metallized polypropylene film capacitor (Box-type)

■ Outline Drawing

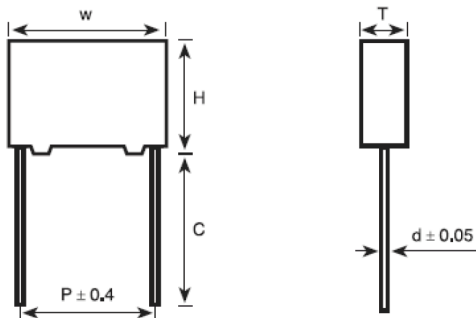

$$W \pm 0.4, H \pm 0.4, T \pm 0.4$$

■ Features

- Metallized polypropylene structure
- Low loss at high frequency
- Small inherent temperature rise
- Plastic case (UL94 V-0), Epoxy resin sealing

■ Typical application

- Widely used in high frequency, DC, AC and pulse circuits
- S-correction circuits for TV sets and monitors

■ Specifications

Reference Standard	GB/T 10190 (IEC 60384-16)						
Climatic Category	55/105/56						
Rated temperature	85°C						
Operating temperature	-55°C~105°C (+85°C to +105°C: decreasing factor 1.25% per °C for U_R)						
Rated Voltage	160Vdc(90Vac); 250Vdc(160Vac); 400Vdc(220Vac); 630Vdc(250Vac); 1 000Vdc(400Vac); 1 600Vdc(600Vac); 2 000Vdc(700Vac)						
Capacitance Range	0.00056~15.0μF						
Capacitance Tolerance	±2% (G), ±2.5% (B), ±3% (H), ±5% (J), ±10% (K), ±20% (M)						
Voltage Proof	1.6 U_R (5s)						
Dissipation Factor	$\leq 10 \times 10^{-4}$ (20°C, 1kHz)						
Insulation Resistance	$\geq 100\ 000\ M\Omega$, $C_N \leq 0.33\ \mu F$			$\geq 30\ 000\ s$, $C_N > 0.33\ \mu F$			
		(20°C, 100V, 1min)					
Maximum Pulse Rise Time(dV/dt) If the working voltage(U) is lower than the rated voltage(U_R),the capacitor can be worked at a higher dV/dt. In this case, the maximum allowed dV/dt is obtain by multiplying the right value with U_R/U .	U_R (V)	dV/dt(V/us)					
		P=5.0	P=7.5	P=10.0	P=15.0	P=22.5	P=27.5
	160	110	310	190	110	65	55
	250	270	660	560	310	130	110
	400	440	900	780	600	300	130
	630	550	1500	1200	900	400	200
	1 000	--	--	2200	2 000	800	--
	1 600	--	--	--	4 500	1 800	--
2 000	--	--	--	9 500	4 500	--	

■ Part number system

The 18 digits part number is formed as follow:

1	2	3	4	5	6	7	8	9	10	11	12	13	14	15	16	17	18
C	3	2															

Digit 1 to 3 Series code

C32=MKP21

Digit 4 to 5 D.C. rated voltage

2C=160V 2E=250V 2G=400V

2J=630V 3A=1000V 3C=1600V

3D=2000V

Digit 6 to 8 Rated capacitance value

For example : 103=10×10³ pF= 0.01μF

Digit 9 Capacitance tolerance

G=±2%, B=±2.5%,H=±3%, J=±5%

K=±10%, M=±20%

Digit 10 Pitch

2=5.0mm 3=7.5mm 4=10mm

6=15mm 9=22.5mm B=27.5mm

Digit 11 Internal use

Digit 12 to 15 Lead form and packaging code

Digit 16 to 18 Internal use

Table 1 Lead form and packaging code

Digit 12		Digit 13		Digit 14		Digit 15	
code	explanation	code	explanation	code	explanation	code	explanation
A	ammo-pack	2	F=5.0mm	0	straight	1	each cap. among two consecutive holes P3=12.7mm,H=18.5mm (For pitch=5.0/7.5mm)
		3	F=7.5mm				5
		4	F=10.0mm				
		6	F=15.0mm				
C	straight lead "C" in the figure above	code	explanation	0		0	Length tolerance ±0.5mm Or standard length
		00	standard lead length (18mm~26mm)				
		45	lead length 4.5mm				

■ Dimensions (mm)

160Vdc (90Vac)							160Vdc (90Vac)							160Vdc (90Vac)						
C _N (μF)	W	H	T	P	d	Part number	C _N (μF)	W	H	T	P	d	Part number	C _N (μF)	W	H	T	P	d	Part number
0.027	7.2	7.5	3.5	5.0	0.5	C322C273-20*****	0.22	13.0	12.0	6.0	10.0	0.6	C322C224-40*****	1.5	26.5	17.0	8.5	22.5	0.8	C322C155-90*****
0.033	7.2	7.5	3.5	5.0	0.5	C322C333-20*****	0.27	13.0	12.0	6.0	10.0	0.6	C322C274-40*****	1.8	26.5	18.5	10.0	22.5	0.8	C322C185-90*****
0.039	7.2	7.5	3.5	5.0	0.5	C322C393-20*****	0.18	17.5	11.0	5.0	15.0	0.8	C322C184-60*****	2.2	26.5	20.0	11.0	22.5	0.8	C322C225-90*****
0.047	7.2	9.5	4.5	5.0	0.6	C322C473-20*****	0.22	17.5	11.0	5.0	15.0	0.8	C322C224-60*****	2.7	26.5	22.0	12.0	22.5	0.8	C322C275-90*****
0.056	7.2	9.5	4.5	5.0	0.6	C322C563-20*****	0.27	17.5	11.0	5.0	15.0	0.8	C322C274-60*****	3.3	26.5	22.0	12.0	22.5	0.8	C322C335-90*****
0.068	7.2	9.5	4.5	5.0	0.6	C322C683-20*****	0.33	17.5	11.0	5.0	15.0	0.8	C322C334-60*****	1.0	32.0	18.0	9.0	27.5	0.8	C322C105-B0*****
0.082	7.2	10.0	5.0	5.0	0.6	C322C823-20*****	0.39	17.5	12.0	6.0	15.0	0.8	C322C394-60*****	1.2	32.0	18.0	9.0	27.5	0.8	C322C125-B0*****
0.10	7.2	10.0	5.0	5.0	0.6	C322C104-20*****	0.47	17.5	12.0	6.0	15.0	0.8	C322C474-60*****	1.5	32.0	18.0	9.0	27.5	0.8	C322C155-B0*****
0.12	7.2	11.0	6.0	5.0	0.6	C322C124-20*****	0.56	17.5	13.5	7.5	15.0	0.8	C322C564-60*****	1.8	32.0	18.0	9.0	27.5	0.8	C322C185-B0*****
0.15	7.2	11.0	6.0	5.0	0.6	C322C154-20*****	0.68	17.5	13.5	7.5	15.0	0.8	C322C684-60*****	2.2	32.0	18.0	9.0	27.5	0.8	C322C225-B0*****
0.068	10.5	9.0	4.0	7.5	0.6	C322C683-30*****	0.82	17.5	14.5	8.5	15.0	0.8	C322C824-60*****	2.7	32.0	20.0	11.0	27.5	0.8	C322C275-B0*****
0.082	10.5	9.0	4.0	7.5	0.6	C322C823-30*****	1.0	17.5	16.0	10.0	15.0	0.8	C322C105-60*****	3.3	32.0	20.0	11.0	27.5	0.8	C322C335-B0*****
0.10	10.5	11.0	5.0	7.5	0.6	C322C104-30*****	1.2	17.5	16.0	10.0	15.0	0.8	C322C125-60*****	3.9	32.0	22.0	13.0	27.5	0.8	C322C395-B0*****
0.12	10.5	11.0	5.0	7.5	0.6	C322C124-30*****	1.5	17.5	19.0	11.0	15.0	0.8	C322C155-60*****	4.7	32.0	28.0	14.0	27.5	0.8	C322C475-B0*****
0.15	10.5	12.0	6.0	7.5	0.6	C322C154-30*****	1.8	17.5	19.0	11.0	15.0	0.8	C322C185-60*****	5.6	32.0	24.5	15.0	27.5	0.8	C322C565-B0*****
0.18	10.5	12.0	6.0	7.5	0.6	C322C184-30*****	0.47	26.5	15.0	6.0	22.5	0.8	C322C474-90*****	6.8	32.0	33.0	18.0	27.5	0.8	C322C685-B0*****
0.082	13.0	9.0	4.0	10.0	0.6	C322C823-40*****	0.56	26.5	15.0	6.0	22.5	0.8	C322C564-90*****	8.2	32.0	33.0	18.0	27.5	0.8	C322C825-B0*****
0.10	13.0	9.0	4.0	10.0	0.6	C322C104-40*****	0.68	26.5	15.0	6.0	22.5	0.8	C322C684-90*****	10.0	32.0	33.0	18.0	27.5	0.8	C322C106-B0*****
0.12	13.0	11.0	5.0	10.0	0.6	C322C124-40*****	0.82	26.5	16.0	7.0	22.5	0.8	C322C824-90*****	12.0	32.0	37.0	22.0	27.5	0.8	C322C126-B0*****
0.15	13.0	11.0	5.0	10.0	0.6	C322C154-40*****	1.0	26.5	16.0	7.0	22.5	0.8	C322C105-90*****	15.0	32.0	37.0	22.0	27.5	0.8	C322C156-B0*****
0.18	13.0	11.0	5.0	10.0	0.6	C322C184-40*****	1.2	26.5	17.0	8.5	22.5	0.8	C322C125-90*****							

Note: 1. “-”=capacitance tolerance code, M=±20%,K=±10%,J=±5%,H=±3%,G=±2%
 2. “*****”=lead form and packing code (refer to table 1)

■ Dimensions (mm)

250Vdc (160Vac)							250Vdc (160Vac)							250Vdc (160Vac)						
C _N (μF)	W	H	T	P	d	Part number	C _N (μF)	W	H	T	P	d	Part number	C _N (μF)	W	H	T	P	d	Part number
0.012	7.2	7.5	3.5	5.0	0.5	C322E123-20*****	0.047	13.0	9.0	4.0	10.0	0.6	C322E473-40*****	0.68	26.5	15.0	6.0	22.5	0.8	C322E684-90*****
0.015	7.2	7.5	3.5	5.0	0.5	C322E153-20*****	0.056	13.0	9.0	4.0	10.0	0.6	C322E563-40*****	0.82	26.5	15.0	6.0	22.5	0.8	C322E824-90*****
0.018	7.2	7.5	3.5	5.0	0.5	C322E183-20*****	0.068	13.0	9.0	4.0	10.0	0.6	C322E683-40*****	1.0	26.5	16.0	7.0	22.5	0.8	C322E105-90*****
0.022	7.2	7.5	3.5	5.0	0.5	C322E223-20*****	0.082	13.0	9.0	4.0	10.0	0.6	C322E823-40*****	1.2	26.5	17.0	8.5	22.5	0.8	C322E125-90*****
0.027	7.2	7.5	3.5	5.0	0.5	C322E273-20*****	0.10	13.0	11.0	5.0	10.0	0.6	C322E104-40*****	1.5	26.5	17.0	8.5	22.5	0.8	C322E155-90*****
0.033	7.2	7.5	3.5	5.0	0.5	C322E333-20*****	0.12	13.0	11.0	5.0	10.0	0.6	C322E124-40*****	1.8	26.5	18.5	10.0	22.5	0.8	C322E185-90*****
0.039	7.2	7.5	3.5	5.0	0.5	C322E393-20*****	0.15	13.0	11.0	5.0	10.0	0.6	C322E154-40*****	2.2	26.5	20.0	11.0	22.5	0.8	C322E225-90*****
0.047	7.2	9.5	4.5	5.0	0.6	C322E473-20*****	0.18	13.0	12.0	6.0	10.0	0.6	C322E184-40*****	2.7	26.5	22.0	12.0	22.5	0.8	C322E275-90*****
0.056	7.2	9.5	4.5	5.0	0.6	C322E563-20*****	0.22	13.0	12.0	6.0	10.0	0.6	C322E224-40*****	0.82	32.0	18.0	9.0	27.5	0.8	C322E824-B0*****
0.068	7.2	10.0	5.0	5.0	0.6	C322E683-20*****	0.10	17.5	11.0	5.0	15.0	0.8	C322E104-60*****	1.0	32.0	18.0	9.0	27.5	0.8	C322E105-B0*****
0.082	7.2	10.0	5.0	5.0	0.6	C322E823-20*****	0.12	17.5	11.0	5.0	15.0	0.8	C322E124-60*****	1.2	32.0	18.0	9.0	27.5	0.8	C322E125-B0*****
0.10	7.2	11.0	6.0	5.0	0.6	C322E104-20*****	0.15	17.5	11.0	5.0	15.0	0.8	C322E154-60*****	1.5	32.0	18.0	9.0	27.5	0.8	C322E155-B0*****
0.12	7.2	11.0	6.0	5.0	0.6	C322E124-20*****	0.18	17.5	11.0	5.0	15.0	0.8	C322E184-60*****	1.8	32.0	18.0	9.0	27.5	0.8	C322E185-B0*****
0.027	10.5	9.0	4.0	7.5	0.6	C322E273-30*****	0.22	17.5	11.0	5.0	15.0	0.8	C322E224-60*****	2.2	32.0	18.0	9.0	27.5	0.8	C322E225-B0*****
0.033	10.5	9.0	4.0	7.5	0.6	C322E333-30*****	0.27	17.5	12.0	6.0	15.0	0.8	C322E274-60*****	2.7	32.0	20.0	11.0	27.5	0.8	C322E275-B0*****
0.039	10.5	9.0	4.0	7.5	0.6	C322E393-30*****	0.33	17.5	12.0	6.0	15.0	0.8	C322E334-60*****	3.3	32.0	20.0	11.0	27.5	0.8	C322E335-B0*****
0.047	10.5	9.0	4.0	7.5	0.6	C322E473-30*****	0.39	17.5	13.5	7.5	15.0	0.8	C322E394-60*****	3.9	32.0	22.0	13.0	27.5	0.8	C322E395-B0*****
0.056	10.5	9.0	4.0	7.5	0.6	C322E563-30*****	0.47	17.5	13.5	7.5	15.0	0.8	C322E474-60*****	4.7	32.0	28.0	14.0	27.5	0.8	C322E475-B0*****
0.068	10.5	9.0	4.0	7.5	0.6	C322E683-30*****	0.56	17.5	13.5	7.5	15.0	0.8	C322E564-60*****	5.6	32.0	24.5	15.0	27.5	0.8	C322E565-B0*****
0.082	10.5	11.0	5.0	7.5	0.6	C322E823-30*****	0.68	17.5	14.5	8.5	15.0	0.8	C322E684-60*****	6.8	32.0	33.0	18.0	27.5	0.8	C322E685-B0*****
0.10	10.5	11.0	5.0	7.5	0.6	C322E104-30*****	0.82	17.5	16.0	10.0	15.0	0.8	C322E824-60*****	8.2	32.0	33.0	18.0	27.5	0.8	C322E825-B0*****
0.12	10.5	11.0	5.0	7.5	0.6	C322E124-30*****	1.0	17.5	16.0	10.0	15.0	0.8	C322E105-60*****	10.0	32.0	33.0	18.0	27.5	0.8	C322E106-B0*****
0.15	10.5	12.0	6.0	7.5	0.6	C322E154-30*****	1.2	17.5	19.0	11.0	15.0	0.8	C322E125-60*****	12.0	32.0	37.0	22.0	27.5	0.8	C322E126-B0*****
0.18	10.5	12.0	6.0	7.5	0.6	C322E184-30*****	0.39	26.5	15.0	6.0	22.5	0.8	C322E394-90*****	15.0	32.0	37.0	22.0	27.5	0.8	C322E156-B0*****
0.033	13.0	9.0	4.0	10.0	0.6	C322E333-40*****	0.47	26.5	15.0	6.0	22.5	0.8	C322E474-90*****							
0.039	13.0	9.0	4.0	10.0	0.6	C322E393-40*****	0.56	26.5	15.0	6.0	22.5	0.8	C322E564-90*****							

Note: 1. “-”=capacitance tolerance code, M=±20%,K=±10%,J=±5%,H=±3%,G=±2%

2. “****”=lead form and packing code (refer to table 1)

■ Dimensions (mm)

400Vdc (220Vac) @							400Vdc (220Vac) @							400Vdc (220Vac) @						
C _N (μF)	W	H	T	P	d	Part number	C _N (μF)	W	H	T	P	d	Part number	C _N (μF)	W	H	T	P	d	Part number
0.0039	7.2	7.5	3.5	5.0	0.5	C322G392-20*****	0.015	13.0	9.0	4.0	10.0	0.6	C322G153-40*****	0.18	26.5	15.0	6.0	22.5	0.8	C322G184-90*****
0.0047	7.2	7.5	3.5	5.0	0.5	C322G472-20*****	0.018	13.0	9.0	4.0	10.0	0.6	C322G183-40*****	0.22	26.5	15.0	6.0	22.5	0.8	C322G224-90*****
0.0056	7.2	7.5	3.5	5.0	0.5	C322G562-20*****	0.022	13.0	9.0	4.0	10.0	0.6	C322G223-40*****	0.27	26.5	15.0	6.0	22.5	0.8	C322G274-90*****
0.0068	7.2	7.5	3.5	5.0	0.5	C322G682-20*****	0.027	13.0	9.0	4.0	10.0	0.6	C322G273-40*****	0.33	26.5	15.0	6.0	22.5	0.8	C322G334-90*****
0.0082	7.2	7.5	3.5	5.0	0.5	C322G822-20*****	0.033	13.0	9.0	4.0	10.0	0.6	C322G333-40*****	0.39	26.5	16.0	7.0	22.5	0.8	C322G394-90*****
0.010	7.2	7.5	3.5	5.0	0.5	C322G103-20*****	0.039	13.0	9.0	4.0	10.0	0.6	C322G393-40*****	0.47	26.5	16.0	7.0	22.5	0.8	C322G474-90*****
0.012	7.2	7.5	3.5	5.0	0.5	C322G123-20*****	0.047	13.0	11.0	5.0	10.0	0.6	C322G473-40*****	0.56	26.5	17.0	8.5	22.5	0.8	C322G564-90*****
0.015	7.2	9.5	4.5	5.0	0.6	C322G153-20*****	0.056	13.0	11.0	5.0	10.0	0.6	C322G563-40*****	0.68	26.5	17.0	8.5	22.5	0.8	C322G684-90*****
0.018	7.2	9.5	4.5	5.0	0.6	C322G183-20*****	0.068	13.0	11.0	5.0	10.0	0.6	C322G683-40*****	0.82	26.5	18.5	10.0	22.5	0.8	C322G824-90*****
0.022	7.2	9.5	4.5	5.0	0.6	C322G223-20*****	0.082	13.0	12.0	6.0	10.0	0.6	C322G823-40*****	1.0	26.5	20.0	11.0	22.5	0.8	C322G105-90*****
0.027	7.2	10.0	5.0	5.0	0.6	C322G273-20*****	0.10	13.0	12.0	6.0	10.0	0.6	C322G104-40*****	1.2	26.5	22.0	12.0	22.5	0.8	C322G125-90*****
0.033	7.2	11.0	6.0	5.0	0.6	C322G333-20*****	0.068	17.5	11.0	5.0	15.0	0.8	C322G683-60*****	1.5	26.5	22.0	12.0	22.5	0.8	C322G155-90*****
0.039	7.2	11.0	6.0	5.0	0.6	C322G393-20*****	0.082	17.5	11.0	5.0	15.0	0.8	C322G823-60*****	0.56	32.0	18.0	9.0	27.5	0.8	C322G564-B0*****
0.047	7.2	11.0	6.0	5.0	0.6	C322G473-20*****	0.10	17.5	11.0	5.0	15.0	0.8	C322G104-60*****	0.68	32.0	18.0	9.0	27.5	0.8	C322G684-B0*****
0.010	10.5	9.0	4.0	7.5	0.6	C322G103-30*****	0.12	17.5	11.0	5.0	15.0	0.8	C322G124-60*****	0.82	32.0	18.0	9.0	27.5	0.8	C322G824-B0*****
0.012	10.5	9.0	4.0	7.5	0.6	C322G123-30*****	0.15	17.5	12.0	6.0	15.0	0.8	C322G154-60*****	1.0	32.0	18.0	9.0	27.5	0.8	C322G105-B0*****
0.015	10.5	9.0	4.0	7.5	0.6	C322G153-30*****	0.18	17.5	12.0	6.0	15.0	0.8	C322G184-60*****	1.2	32.0	20.0	11.0	27.5	0.8	C322G125-B0*****
0.018	10.5	9.0	4.0	7.5	0.6	C322G183-30*****	0.22	17.5	13.5	7.5	15.0	0.8	C322G224-60*****	1.5	32.0	20.0	11.0	27.5	0.8	C322G155-B0*****
0.022	10.5	9.0	4.0	7.5	0.6	C322G223-30*****	0.27	17.5	13.5	7.5	15.0	0.8	C322G274-60*****	1.8	32.0	22.0	13.0	27.5	0.8	C322G185-B0*****
0.027	10.5	9.0	4.0	7.5	0.6	C322G273-30*****	0.33	17.5	14.5	8.5	15.0	0.8	C322G334-60*****	2.2	32.0	24.5	15.0	27.5	0.8	C322G225-B0*****
0.033	10.5	11.0	5.0	7.5	0.6	C322G333-30*****	0.39	17.5	16.0	10.0	15.0	0.8	C322G394-60*****	2.7	32.0	28.0	14.0	27.5	0.8	C322G275-B0*****
0.039	10.5	11.0	5.0	7.5	0.6	C322G393-30*****	0.47	17.5	16.0	10.0	15.0	0.8	C322G474-60*****	3.3	32.0	33.0	18.0	27.5	0.8	C322G335-B0*****
0.047	10.5	11.0	5.0	7.5	0.6	C322G473-30*****	0.56	17.5	19.0	11.0	15.0	0.8	C322G564-60*****	3.9	32.0	33.0	18.0	27.5	0.8	C322G395-B0*****
0.056	10.5	12.0	6.0	7.5	0.6	C322G563-30*****	0.68	17.5	19.0	11.0	15.0	0.8	C322G684-60*****	4.7	32.0	37.0	22.0	27.5	0.8	C322G475-B0*****
0.068	10.5	12.0	6.0	7.5	0.6	C322G683-30*****								5.6	32.0	37.0	22.0	27.5	0.8	C322G565-B0*****

Note: 1. "-"=capacitance tolerance code, M=±20%,K=±10%,J=±5%,H=±3%,G=±2%

2. "****"=lead form and packing code (refer to table 1)

3. "@" Not suitable for across-the-line application. Pls refer to Interference Suppression Capacitors.

■ Dimensions (mm)

630Vdc (250Vac) @							630Vdc (250Vac) @							630Vdc (250Vac) @						
C _N (μF)	W	H	T	P	d	Part number	C _N (μF)	W	H	T	P	d	Part number	C _N (μF)	W	H	T	P	d	Part number
0.0010	7.2	7.5	3.5	5.0	0.5	C322J102-20*****	0.027	10.5	12.0	6.0	7.5	0.6	C322J273-30*****	0.12	17.5	13.5	7.5	15.0	0.8	C322J124-60*****
0.0012	7.2	7.5	3.5	5.0	0.5	C322J122-20*****	0.033	10.5	12.0	6.0	7.5	0.6	C322J333-30*****	0.15	17.5	13.5	7.5	15.0	0.8	C322J154-60*****
0.0015	7.2	7.5	3.5	5.0	0.5	C322J152-20*****	0.0010	13.0	9.0	4.0	10.0	0.6	C322J102-40*****	0.18	17.5	14.5	8.5	15.0	0.8	C322J184-60*****
0.0018	7.2	7.5	3.5	5.0	0.5	C322J182-20*****	0.0012	13.0	9.0	4.0	10.0	0.6	C322J122-40*****	0.22	17.5	16.0	10.0	15.0	0.8	C322J224-60*****
0.0022	7.2	7.5	3.5	5.0	0.5	C322J222-20*****	0.0015	13.0	9.0	4.0	10.0	0.6	C322J152-40*****	0.27	17.5	19.0	11.0	15.0	0.8	C322J274-60*****
0.0027	7.2	7.5	3.5	5.0	0.5	C322J272-20*****	0.0018	13.0	9.0	4.0	10.0	0.6	C322J182-40*****	0.33	17.5	19.0	11.0	15.0	0.8	C322J334-60*****
0.0033	7.2	7.5	3.5	5.0	0.5	C322J332-20*****	0.0022	13.0	9.0	4.0	10.0	0.6	C322J222-40*****	0.082	26.5	15.0	6.0	22.5	0.8	C322J823-90*****
0.0039	7.2	9.5	4.5	5.0	0.6	C322J392-20*****	0.0027	13.0	9.0	4.0	10.0	0.6	C322J272-40*****	0.10	26.5	15.0	6.0	22.5	0.8	C322J104-90*****
0.0047	7.2	9.5	4.5	5.0	0.6	C322J472-20*****	0.0033	13.0	9.0	4.0	10.0	0.6	C322J332-40*****	0.12	26.5	15.0	6.0	22.5	0.8	C322J124-90*****
0.0056	7.2	10.0	5.0	5.0	0.6	C322J562-20*****	0.0039	13.0	9.0	4.0	10.0	0.6	C322J392-40*****	0.15	26.5	15.0	6.0	22.5	0.8	C322J154-90*****
0.0068	7.2	10.0	5.0	5.0	0.6	C322J682-20*****	0.0047	13.0	9.0	4.0	10.0	0.6	C322J472-40*****	0.18	26.5	15.0	6.0	22.5	0.8	C322J184-90*****
0.0082	7.2	11.0	6.0	5.0	0.6	C322J822-20*****	0.0056	13.0	9.0	4.0	10.0	0.6	C322J562-40*****	0.22	26.5	16.0	7.0	22.5	0.8	C322J224-90*****
0.010	7.2	11.0	6.0	5.0	0.6	C322J103-20*****	0.0068	13.0	9.0	4.0	10.0	0.6	C322J682-40*****	0.27	26.5	17.0	8.5	22.5	0.8	C322J274-90*****
0.012	7.2	11.0	6.0	5.0	0.6	C322J123-20*****	0.0082	13.0	9.0	4.0	10.0	0.6	C322J822-40*****	0.33	26.5	17.0	8.5	22.5	0.8	C322J334-90*****
0.0010	10.5	9.0	4.0	7.5	0.6	C322J102-30*****	0.010	13.0	9.0	4.0	10.0	0.6	C322J103-40*****	0.39	26.5	18.5	10.0	22.5	0.8	C322J394-90*****
0.0012	10.5	9.0	4.0	7.5	0.6	C322J122-30*****	0.012	13.0	9.0	4.0	10.0	0.6	C322J123-40*****	0.47	26.5	18.5	10.0	22.5	0.8	C322J474-90*****
0.0015	10.5	9.0	4.0	7.5	0.6	C322J152-30*****	0.015	13.0	9.0	4.0	10.0	0.6	C322J153-40*****	0.56	26.5	20.0	11.0	22.5	0.8	C322J564-90*****
0.0018	10.5	9.0	4.0	7.5	0.6	C322J182-30*****	0.018	13.0	9.0	4.0	10.0	0.6	C322J183-40*****	0.68	26.5	22.0	12.0	22.5	0.8	C322J684-90*****
0.0022	10.5	9.0	4.0	7.5	0.6	C322J222-30*****	0.022	13.0	11.0	5.0	10.0	0.6	C322J223-40*****	0.33	32.0	18.0	9.0	27.5	0.8	C322J334-B0*****
0.0027	10.5	9.0	4.0	7.5	0.6	C322J272-30*****	0.027	13.0	11.0	5.0	10.0	0.6	C322J273-40*****	0.39	32.0	18.0	9.0	27.5	0.8	C322J394-B0*****
0.0033	10.5	9.0	4.0	7.5	0.6	C322J332-30*****	0.033	13.0	11.0	5.0	10.0	0.6	C322J333-40*****	0.47	32.0	18.0	9.0	27.5	0.8	C322J474-B0*****
0.0039	10.5	9.0	4.0	7.5	0.6	C322J392-30*****	0.039	13.0	12.0	6.0	10.0	0.6	C322J393-40*****	0.56	32.0	20.0	11.0	27.5	0.8	C322J564-B0*****
0.0047	10.5	9.0	4.0	7.5	0.6	C322J472-30*****	0.047	13.0	12.0	6.0	10.0	0.6	C322J473-40*****	0.68	32.0	20.0	11.0	27.5	0.8	C322J684-B0*****
0.0056	10.5	9.0	4.0	7.5	0.6	C322J562-30*****	0.027	17.5	11.0	5.0	15.0	0.8	C322J273-60*****	0.82	32.0	20.0	11.0	27.5	0.8	C322J824-B0*****
0.0068	10.5	9.0	4.0	7.5	0.6	C322J682-30*****	0.033	17.5	11.0	5.0	15.0	0.8	C322J333-60*****	1.0	32.0	22.0	13.0	27.5	0.8	C322J105-B0*****
0.0082	10.5	9.0	4.0	7.5	0.6	C322J822-30*****	0.039	17.5	11.0	5.0	15.0	0.8	C322J393-60*****	1.2	32.0	24.5	15.0	27.5	0.8	C322J125-B0*****
0.010	10.5	9.0	4.0	7.5	0.6	C322J103-30*****	0.047	17.5	11.0	5.0	15.0	0.8	C322J473-60*****	1.5	32.0	28.0	14.0	27.5	0.8	C322J155-B0*****
0.012	10.5	9.0	4.0	7.5	0.6	C322J123-30*****	0.056	17.5	11.0	5.0	15.0	0.8	C322J563-60*****	1.8	32.0	33.0	18.0	27.5	0.8	C322J185-B0*****
0.015	10.5	11.0	5.0	7.5	0.6	C322J153-30*****	0.068	17.5	12.0	6.0	15.0	0.8	C322J683-60*****	2.2	32.0	33.0	18.0	27.5	0.8	C322J225-B0*****
0.018	10.5	11.0	5.0	7.5	0.6	C322J183-30*****	0.082	17.5	12.0	6.0	15.0	0.8	C322J823-60*****	2.7	32.0	37.0	22.0	27.5	0.8	C322J275-B0*****
0.022	10.5	11.0	5.0	7.5	0.6	C322J223-30*****	0.10	17.5	13.5	7.5	15.0	0.8	C322J104-60*****	3.3	32.0	37.0	22.0	27.5	0.8	C322J335-B0*****

- Note: 1. “-”=capacitance tolerance code, M=±20%,K=±10%,J=±5%
 2. “*****”=lead form and packing code (refer to table 1)
 3. “@” Not suitable for across-the-line applications.Pls refer to Interference Suppression Capacitors.

■ Dimensions (mm)

1 000Vdc(400Vac)							1 600Vdc(600Vac)							2 000Vdc(700Vac)							
C _N (μF)	W	H	T	P	d	Part number	C _N (μF)	W	H	T	P	d	Part number	C _N (μF)	W	H	T	P	d	Part number	
0.0010	13.0	9.0	4.0	10.0	0.6	C323A102-40****+	0.00056	17.5	11.0	5.0	15.0	0.8	C323C561-60****+	0.00056	17.5	11.0	5.0	15.0	0.8	C323D561-60****+	
0.0012	13.0	9.0	4.0	10.0	0.6	C323A122-40****+	0.00062	17.5	11.0	5.0	15.0	0.8	C323C621-60****+	0.00062	17.5	11.0	5.0	15.0	0.8	C323D621-60****+	
0.0015	13.0	9.0	4.0	10.0	0.6	C323A152-40****+	0.00068	17.5	11.0	5.0	15.0	0.8	C323C681-60****+	0.00068	17.5	11.0	5.0	15.0	0.8	C323D681-60****+	
0.0018	13.0	9.0	4.0	10.0	0.6	C323A182-40****+	0.00082	17.5	11.0	5.0	15.0	0.8	C323C821-60****+	0.00082	17.5	11.0	5.0	15.0	0.8	C323D821-60****+	
0.0022	13.0	9.0	4.0	10.0	0.6	C323A222-40****+	0.0010	17.5	11.0	5.0	15.0	0.8	C323C102-60****+	0.0010	17.5	11.0	5.0	15.0	0.8	C323D102-60****+	
0.0027	13.0	9.0	4.0	10.0	0.6	C323A272-40****+	0.0012	17.5	11.0	5.0	15.0	0.8	C323C122-60****+	0.0012	17.5	11.0	5.0	15.0	0.8	C323D122-60****+	
0.0033	13.0	9.0	4.0	10.0	0.6	C323A332-40****+	0.0015	17.5	11.0	5.0	15.0	0.8	C323C152-60****+	0.0015	17.5	11.0	5.0	15.0	0.8	C323D152-60****+	
0.0039	13.0	9.0	4.0	10.0	0.6	C323A392-40****+	0.0018	17.5	11.0	5.0	15.0	0.8	C323C182-60****+	0.0018	17.5	11.0	5.0	15.0	0.8	C323D182-60****+	
0.0047	13.0	11.0	5.0	10.0	0.6	C323A472-40****+	0.0022	17.5	11.0	5.0	15.0	0.8	C323C222-60****+	0.0022	17.5	11.0	5.0	15.0	0.8	C323D222-60****+	
0.0056	13.0	11.0	5.0	10.0	0.6	C323A562-40****+	0.0027	17.5	11.0	5.0	15.0	0.8	C323C272-60****+	0.0027	17.5	11.0	5.0	15.0	0.8	C323D272-60****+	
0.0068	13.0	11.0	5.0	10.0	0.6	C323A682-40****+	0.0033	17.5	11.0	5.0	15.0	0.8	C323C332-60****+	0.0033	17.5	11.0	5.0	15.0	0.8	C323D332-60****+	
0.0082	13.0	12.0	6.0	10.0	0.6	C323A822-40****+	0.0039	17.5	11.0	5.0	15.0	0.8	C323C392-60****+	0.0039	17.5	11.0	5.0	15.0	0.8	C323D392-60****+	
0.010	13.0	12.0	6.0	10.0	0.6	C323A103-40****+	0.0047	17.5	11.0	5.0	15.0	0.8	C323C472-60****+	0.0047	17.5	11.0	5.0	15.0	0.8	C323D472-60****+	
0.0022	17.5	11.0	5.0	15.0	0.8	C323A222-60****+	0.0056	17.5	11.0	5.0	15.0	0.8	C323C562-60****+	0.0056	17.5	12.0	6.0	15.0	0.8	C323D562-60****+	
0.0027	17.5	11.0	5.0	15.0	0.8	C323A272-60****+	0.0068	17.5	11.0	5.0	15.0	0.8	C323C682-60****+	0.0068	17.5	12.0	6.0	15.0	0.8	C323D682-60****+	
0.0033	17.5	11.0	5.0	15.0	0.8	C323A332-60****+	0.0082	17.5	12.0	6.0	15.0	0.8	C323C822-60****+	0.0082	17.5	13.5	7.5	15.0	0.8	C323D822-60****+	
0.0039	17.5	11.0	5.0	15.0	0.8	C323A392-60****+	0.010	17.5	12.0	6.0	15.0	0.8	C323C103-60****+	0.010	17.5	13.5	7.5	15.0	0.8	C323D103-60****+	
0.0047	17.5	11.0	5.0	15.0	0.8	C323A472-60****+	0.012	17.5	12.0	6.0	15.0	0.8	C323C123-60****+	0.012	17.5	14.5	8.5	15.0	0.8	C323D123-60****+	
0.0056	17.5	11.0	5.0	15.0	0.8	C323A562-60****+	0.015	17.5	13.5	7.5	15.0	0.8	C323C153-60****+	0.015	17.5	14.5	8.5	15.0	0.8	C323D153-60****+	
0.0068	17.5	11.0	5.0	15.0	0.8	C323A682-60****+	0.018	17.5	13.5	7.5	15.0	0.8	C323C183-60****+	0.018	17.5	16.0	10.0	15.0	0.8	C323D183-60****+	
0.0082	17.5	11.0	5.0	15.0	0.8	C323A822-60****+	0.022	17.5	14.5	8.5	15.0	0.8	C323C223-60****+	0.022	17.5	19.0	11.0	15.0	0.8	C323D223-60****+	
0.010	17.5	11.0	5.0	15.0	0.8	C323A103-60****+	0.027	17.5	16.0	10.0	15.0	0.8	C323C273-60****+	0.0068	26.5	15.0	6.0	22.5	0.8	C323D682-90****+	
0.012	17.5	11.0	5.0	15.0	0.8	C323A123-60****+	0.033	17.5	16.0	10.0	15.0	0.8	C323C333-60****+	0.0082	26.5	15.0	6.0	22.5	0.8	C323D822-90****+	
0.015	17.5	12.0	6.0	15.0	0.8	C323A153-60****+	0.039	17.5	19.0	11.0	15.0	0.8	C323C393-60****+	0.010	26.5	15.0	6.0	22.5	0.8	C323D103-90****+	
0.018	17.5	12.0	6.0	15.0	0.8	C323A183-60****+	0.047	17.5	19.0	11.0	15.0	0.8	C323C473-60****+	0.012	26.5	15.0	6.0	22.5	0.8	C323D123-90****+	
0.022	17.5	13.5	7.5	15.0	0.8	C323A223-60****+	0.015	26.5	15.0	6.0	22.5	0.8	C323C153-90****+	0.015	26.5	15.0	6.0	22.5	0.8	C323D153-90****+	
0.027	17.5	13.5	7.5	15.0	0.8	C323A273-60****+	0.018	26.5	15.0	6.0	22.5	0.8	C323C183-90****+	0.018	26.5	16.0	7.0	22.5	0.8	C323D183-90****+	
0.033	17.5	14.5	8.5	15.0	0.8	C323A333-60****+	0.022	26.5	15.0	6.0	22.5	0.8	C323C223-90****+	0.022	26.5	17.0	8.5	22.5	0.8	C323D223-90****+	
0.039	17.5	16.0	10.0	15.0	0.8	C323A393-60****+	0.027	26.5	16.0	7.0	22.5	0.8	C323C273-90****+	0.027	26.5	17.0	8.5	22.5	0.8	C323D273-90****+	
0.047	17.5	16.0	10.0	15.0	0.8	C323A473-60****+	0.033	26.5	16.0	7.0	22.5	0.8	C323C333-90****+	0.033	26.5	18.5	10.0	22.5	0.8	C323D333-90****+	
0.056	17.5	19.0	11.0	15.0	0.8	C323A563-60****+	0.039	26.5	17.0	8.5	22.5	0.8	C323C393-90****+	0.039	26.5	18.5	10.0	22.5	0.8	C323D393-90****+	
0.068	17.5	19.0	11.0	15.0	0.8	C323A683-60****+	0.047	26.5	18.5	10.0	22.5	0.8	C323C473-90****+	0.047	26.5	22.0	12.0	22.5	0.8	C323D473-90****+	
0.018	26.5	15.0	6.0	22.5	0.8	C323A183-90****+	0.056	26.5	18.5	10.0	22.5	0.8	C323C563-90****+	0.056	26.5	22.0	12.0	22.5	0.8	C323D563-90****+	
0.022	26.5	15.0	6.0	22.5	0.8	C323A223-90****+	0.068	26.5	22.0	12.0	22.5	0.8	C323C683-90****+								
0.027	26.5	15.0	6.0	22.5	0.8	C323A273-90****+	0.082	26.5	22.0	12.0	22.5	0.8	C323C823-90****+								
0.033	26.5	15.0	6.0	22.5	0.8	C323A333-90****+	0.10	26.5	22.0	12.0	22.5	0.8	C323C104-90****+								
0.039	26.5	15.0	6.0	22.5	0.8	C323A393-90****+															
0.047	26.5	16.0	7.0	22.5	0.8	C323A473-90****+															
0.056	26.5	16.0	7.0	22.5	0.8	C323A563-90****+															
0.068	26.5	17.0	8.5	22.5	0.8	C323A683-90****+															
0.082	26.5	17.0	8.5	22.5	0.8	C323A823-90****+															
0.10	26.5	18.5	10.0	22.5	0.8	C323A104-90****+															
0.12	26.5	22.0	12.0	22.5	0.8	C323A124-90****+															
0.15	26.5	22.0	12.0	22.5	0.8	C323A154-90****+															

Note: 1. “-”=capacitance tolerance code, M=±20%,K=±10%,J=±5%,H=±3%,G=±2%
 2. “****”=lead form and packaging code (refer to table 1).

■ MAX. VOLTAGE(Vr.m.s) VERSUS FREQUENCY

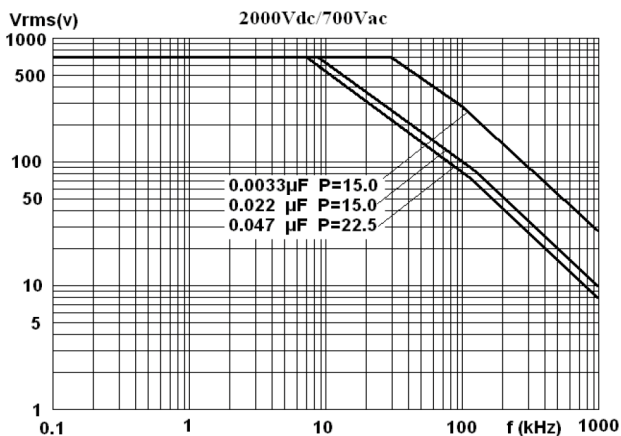
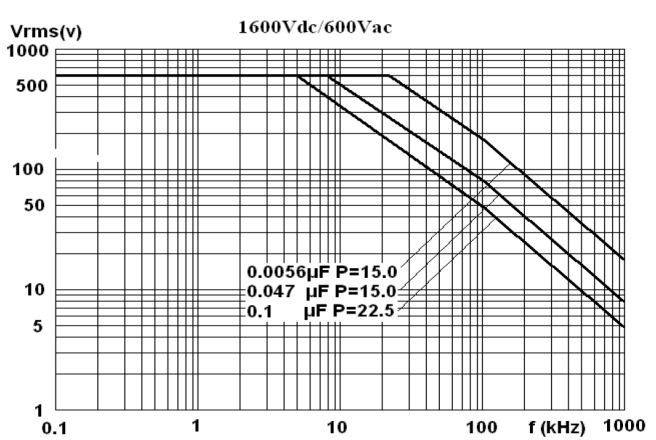
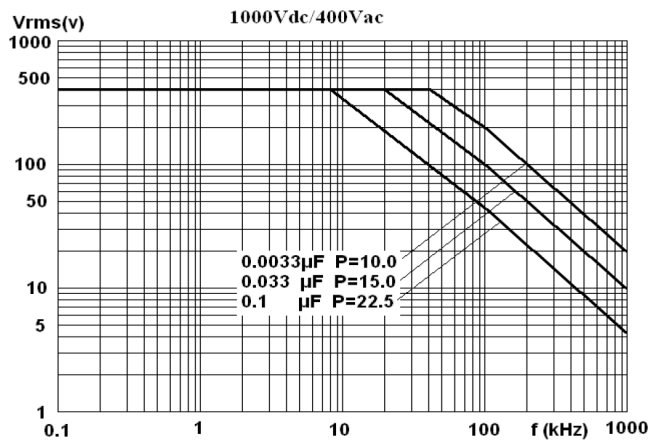
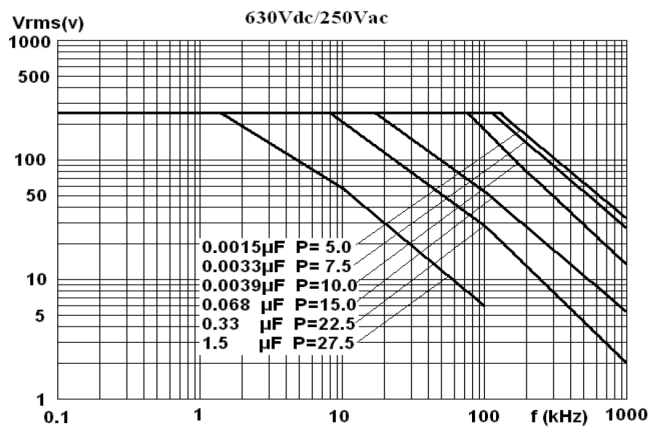
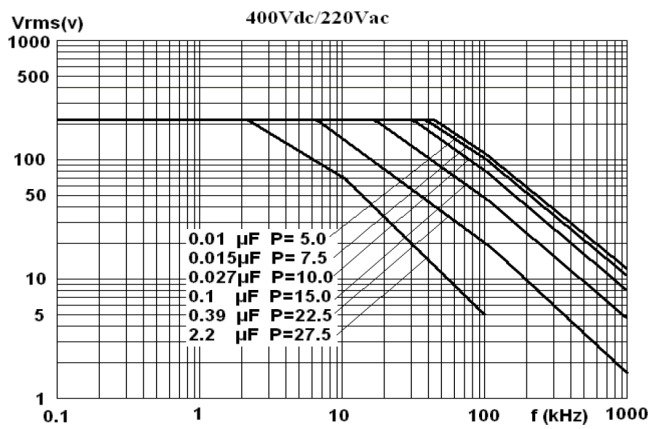
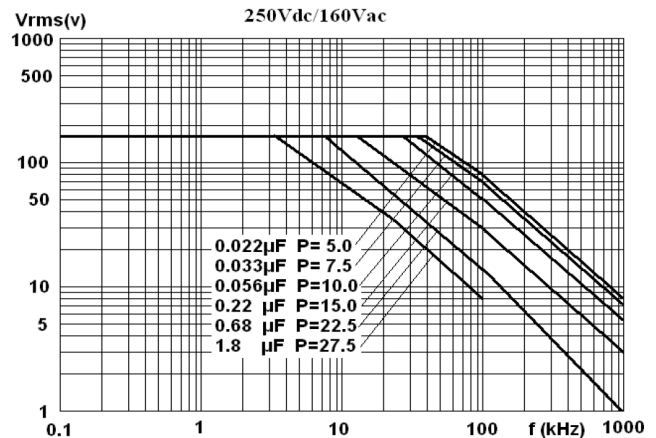
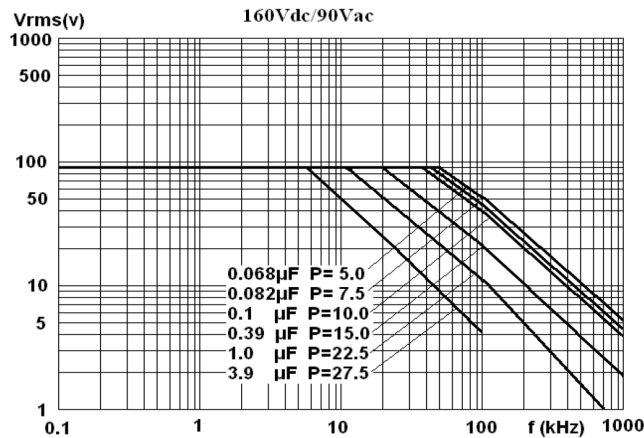

Note: sinusoidal wave-form, environment temperature $\leq 85^{\circ}\text{C}$, internal temperature rise $\Delta T=10^{\circ}\text{C}$, p (pitch) in mm..

■ MAX. CURRENT(I_{r.m.s}) VERSUS FREQUENCY

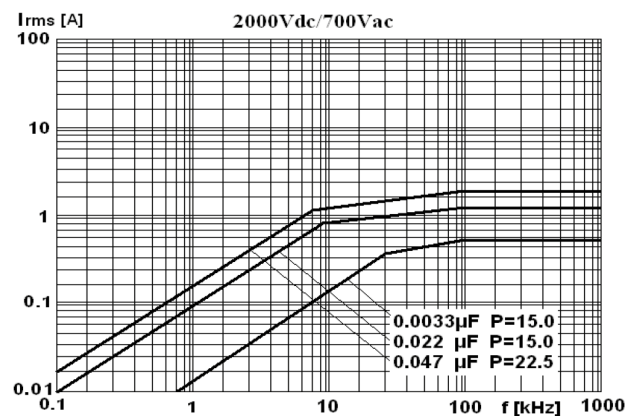
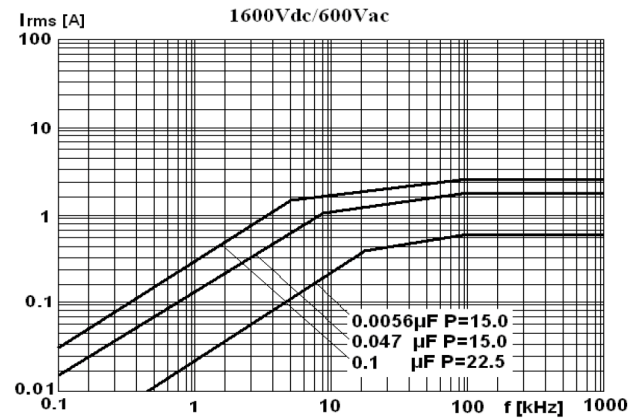
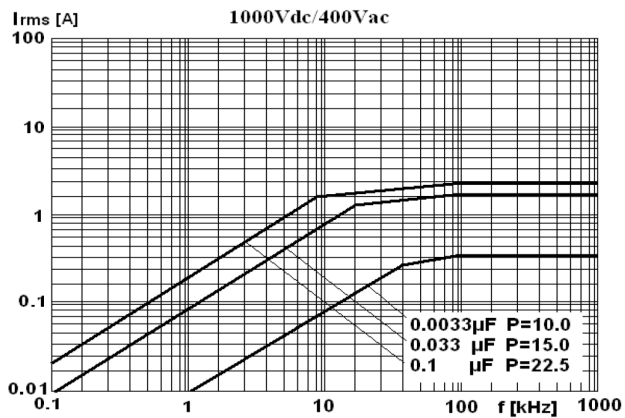
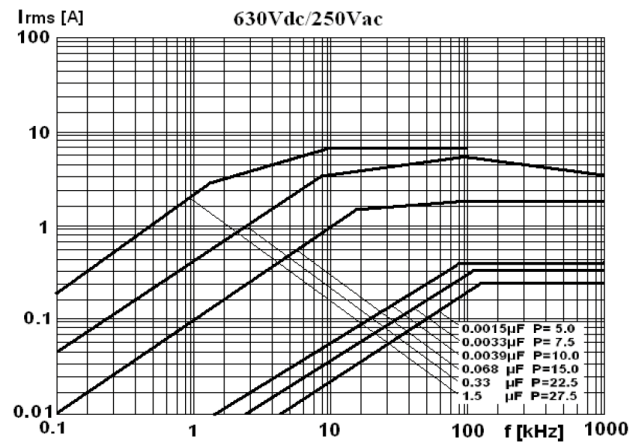
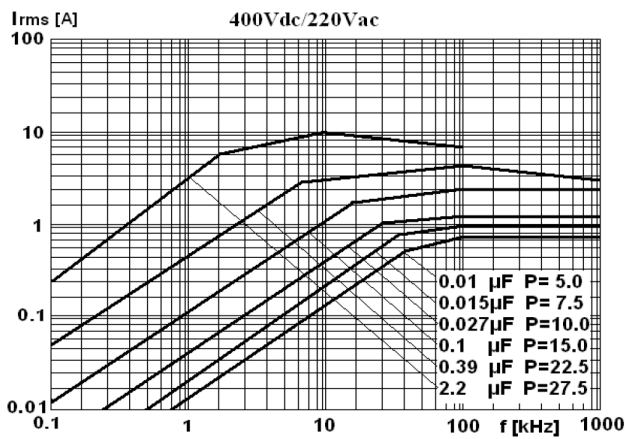
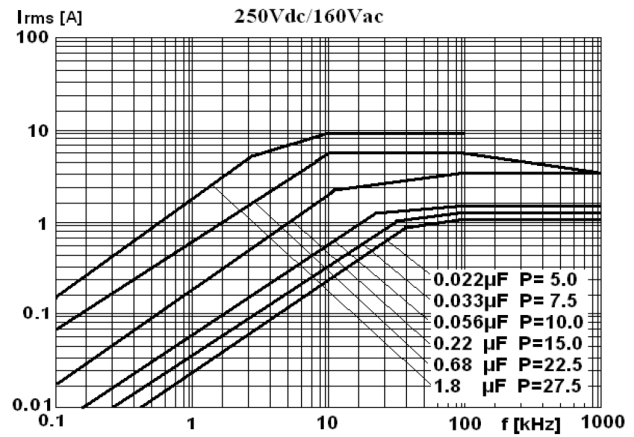
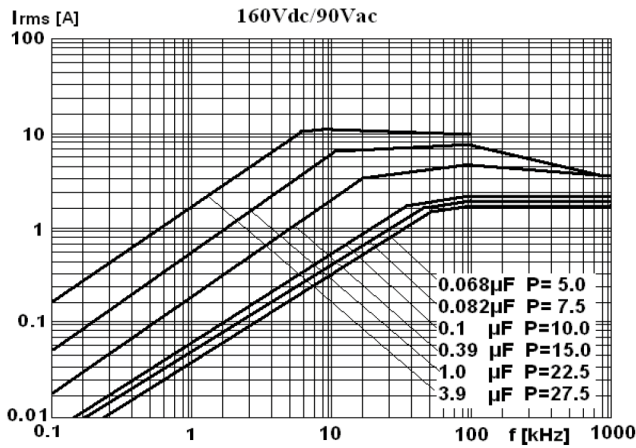

Note: sinusoidal wave-form, environment temperature $\leq 85^{\circ}\text{C}$, internal temperature rise $\Delta T=10^{\circ}\text{C}$, p (pitch) in mm.

■ Test Method And Performance

No.	Item	Performance	Test method(IEC 60384-16)
1	Solderability	Good quality of tinning	Solder temperature:245°C±5°C Immersion time: 2.0s±0.5s
2	Initial measurement	Capacitance Tgδ:1kHz, C>1.0μF 10kHz, C≤1.0μF	
	Terminal strength	There shall be no visible damage	Tension: 0.6≤φd≤0.8mm, 10N φd=1.0mm, 20N Bend: 0.6≤φd≤0.8mm, 5N φd=1.0mm, 10N The terminals shall be bent 2 times in each direction.
	Resistance to solder heat	There shall be no visible damage	Solder temperature:260°C±5°C Immersion time: 10s±1s
	Final measurement	ΔC/C ≤±3%(relative to the initial value) Increase of tgδ: ≤0.004 (10kHz,C≤1.0μF) ≤0.004 (1kHz,C>1.0μF)	
3	Initial measurement	Capacitance Tgδ:1kHz, C>1.0μF 10kHz, C≤1.0μF	
	Rapid change of temperature	There shall be no evidence of deterioration.	θ _A =-40°C, θ _B =+85°C 5 cycles, Duration: t=30min
3	Vibration	There shall be no evidence of deterioration.	Amplitude 0.75mm or acceleration 98m/s ² (whichever is the smaller severity), f: 10Hz to 500Hz.Three directions, 2h for each direction, total 6h.
	Bump	There shall be no evidence of deterioration.	4 000 times, Acceleration: 390m/s ² ,Pulse duration, 6ms
	Final measurement	ΔC/C ≤±3%(relative to the initial value) Increase of tgδ: ≤0.004 (10kHz, C≤1.0μF) ≤0.004 (1kHz, C>1.0μF) IR: ≥ 50% of the rated value	
4	climate sequence	Initial measurement	Capacitance Tgδ:1kHz, C>1.0μF 10kHz, C≤1.0μF
		Dry heat	+85°C, 16h
		Damp heat, Cyclic	Test Db, Severity: b, the first cycle
		Cold	-40°C, 2h
		Low air pressure	There shall be no permanent breakdown, flashover or other harmful deformation when applying U _R at the last 1 minute. 15°C~35°C, 8.5kPa, 1h,

No.	Item		Performance	Test method(IEC 60384-16)
4	climate sequence (continue)	Damp heat, cyclic other		Test Db, Severity b, the other cycles, Applying U_R for 1 minute after the test finished.
		Final measurement	There shall be no evidence of deterioration and the marking shall be legible. $\Delta C/C \leq \pm 5\%$ (relative to the initial value) Increase of $\text{tg}\delta$: ≤ 0.005 (10kHz, $C \leq 1.0\mu\text{F}$) ≤ 0.005 (1kHz, $C > 1.0\mu\text{F}$) IR: $\geq 50\%$ of the rated value	
5	Damp heat steady state		There shall be no evidence of deterioration and the marking shall be legible. $\Delta C/C \leq \pm 5\%$ (relative to the initial value) Increase of $\text{tg}\delta \leq 0.002$ (1kHz) IR: $\geq 50\%$ of the rated value	Temperature: $40^\circ\text{C} \pm 2^\circ\text{C}$ Humidity: $93 \pm 3\%$ RH Duration: 56 days
6	Endurance		$\Delta C/C \leq \pm 5\%$ (relative to the initial value) Increase of $\text{tg}\delta$: ≤ 0.004 (10kHz, $C \leq 1.0\mu\text{F}$) ≤ 0.004 (1kHz, $C > 1.0\mu\text{F}$) IR: $\geq 50\%$ of the rated value	Temperature: $+85^\circ\text{C}$ Voltage: $1.25 \times U_R$ (50Hz) Duration: 1 000h
7	Temperature characteristic		Measuring capacitance at test point b, d, f: Characteristic at lower category temperature -40°C : $0 \leq (C_b - C_d) / C_d \leq +3\%$ Characteristic at upper category temperature $+85^\circ\text{C}$: $-3.25\% \leq (C_f - C_d) / C_d \leq 0$	Static method: The capacitors should be kept at the following temperature in turn: a. $(+20 \pm 2)^\circ\text{C}$, b. $(-40 \pm 2)^\circ\text{C}$, d. $(20 \pm 2)^\circ\text{C}$, f. $(+85 \pm 2)^\circ\text{C}$, g. $(+20 \pm 2)^\circ\text{C}$
8	Charging and discharging		$\Delta C/C \leq \pm 5\%$ (relative to the initial value) Increase of $\text{tg}\delta$: ≤ 0.005 (10kHz, $C \leq 1.0\mu\text{F}$) ≤ 0.005 (1kHz, $C > 1.0\mu\text{F}$) IR: $\geq 50\%$ of the rated value	Times: 10 000 Duration of charging: 0.5s Duration of discharging: 0.5s Charging voltage: rated voltage U_R Charging resistance: $220 / C_N (\Omega)$ Discharging resistance: $U_R \div C_N \div dv/dt (\Omega)$ C_N : rated capacitance (μF) dv/dt value: see P2

■ Quality ensuring test (before shipment):

Inspection item (each batch)	Inspection level (GB 2828)	
	IL	AQL
Appearance inspection	II	1.5%
Dimensions		
Capacitance	II	0.65%
Tangent of the loss angle		
Dielectric strength		
Insulation resistance		
Solderability	S-3	2.5%

■ Marking

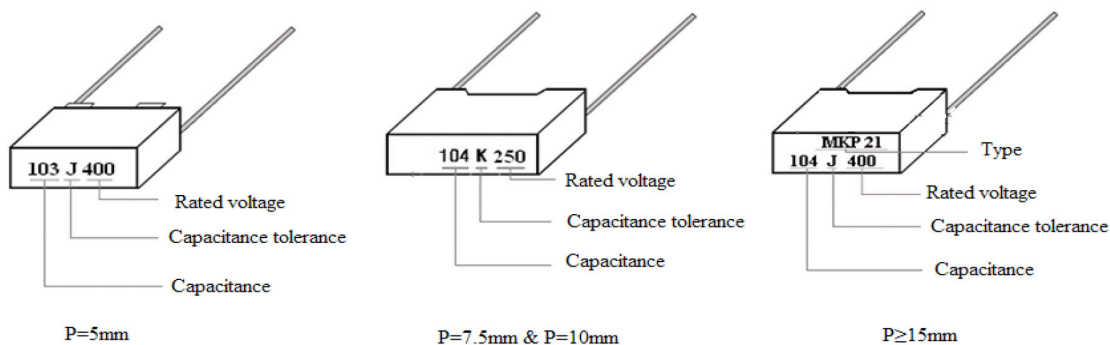

■ Taping specification for box-type capacitors

▲ Outline Drawing

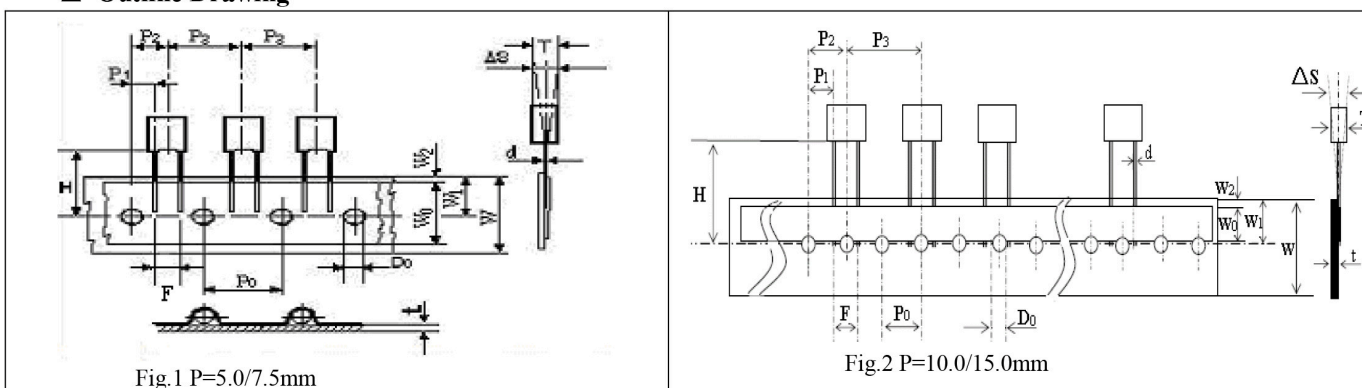

▲ Taping Dimensions(mm)

Technology index title	Code	Dimensions				
		P=5.0	P=7.5	P=10.0	P=15.0	Tolerance
Taping type	—	Fig 1	Fig 1	Fig2	Fig 2	—
Part number	Ammo-pack	A201	A301	A405	A605	
Digit12-15						
Taping pitch	P ₃	12.7	12.7	25.4	25.4	±1.0
Feed hole pitch	P ₀	12.7	12.7	12.7	12.7	±0.3
Center of wire	P ₁	3.85	2.6	7.7	5.2	±0.7
Center of body	P ₂	6.35	6.35	12.7	12.7	±1.3
Pitch of taping wire	F**	5.0	7.5	10.0	15.0	+0.6 -0.1
Component alignment	ΔS	0	0	0	0	±2.0
Height of component from tape center	H***	18.5	18.5	18.5	18.5	±0.5
Carrier tape width	W	18.0	18.0	18.0	18.0	+1.0 -0.5
Hold down tape width	W ₀	6min	10min	10min	10min	—
Hole position	W ₁	9.0	9.0	9.0	9.0	±0.5
Hold down tape position	W ₂	3max	3max	3max	3max	—
Feed hole dia.	D ₀	4.0	4.0	4.0	4.0	±0.2
Tape thickness	t	0.7	0.7	0.7	0.7	±0.2

▲ Packing Quantity

Pitch (mm)	Box thickness T(mm)	Ammo-pack (pcs/box)	
		Domestic	Export
5.0	2.5	2500	2 000
	3.5	1 700	1 500
	4.5	1 400	1 300
	5.0	1 200	1 000
	6.0	1 000	800
7.5	3.5	1 700	1 500
	4.0	1 500	1 350
	5.0	1 200	1 050
	6.0	1 000	850
10.0/ 15.0	4.0	750	650
	5.0	600	500
	6.0	500	450
15.0	7.5	400	350
	8.5	350	300
	10.0	300	250
	11.0	250	220

Note: * P₀=15mm is also available;

**F can be other lead spacing;

***H=16.5mm is available;

■ Packing box sizes(mm)

1. Out packing box for bulk

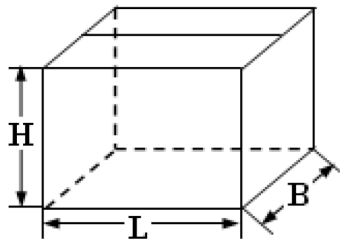

L:375±5
B:375±5
H:265±5

2. Inner packing box for bulk

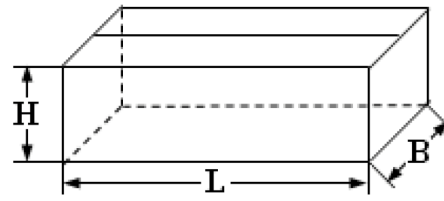

L:355±3
B:175±3
H:118±3

3. Box sizes for Ammo-pack

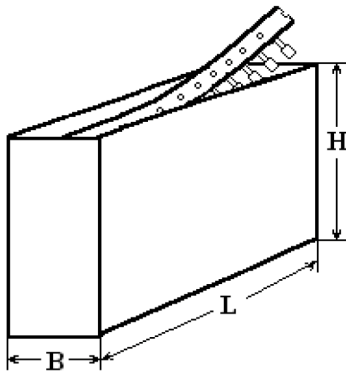

L:330±3
B:48±3
H:260±3