

DESCRIPTION:

The SST20A-600CW triac is suitable for general purpose AC switching. It can be used as an ON/OFF function in applications such as heating regulation, induction motor starting circuits, for phase control operation in light dimmers, motor speed controllers. SST20A-600CW snubberless triac is especially recommended for use on inductive loads. By using an internal ceramic pad, SST20A-600CW provides a rated insulation voltage of 2500 VRMS, complying with UL standards (File ref: E252906). Package TO-220A is RoHS compliant.

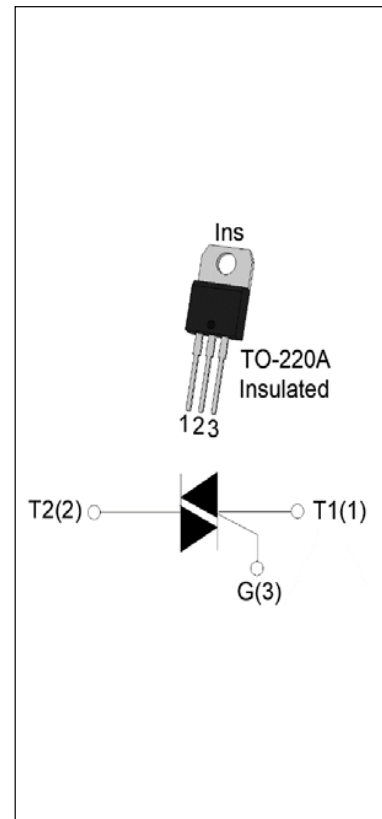

MAIN FEATURES

Symbol	Value	Unit
$I_{T(RMS)}$	20	A
V_{DRM}/V_{RRM}	600	V
$I_{GT\ I/II/III}$	35/35/35	mA

ABSOLUTE MAXIMUM RATINGS

Parameter	Symbol	Value	Unit
Storage junction temperature range	T_{stg}	-40-150	°C
Operating junction temperature range	T_j	-40-125	°C
Repetitive peak off-state voltage ($T_j=25^\circ\text{C}$)	V_{DRM}	600	V
Repetitive peak reverse voltage ($T_j=25^\circ\text{C}$)	V_{RRM}	600	V
RMS on-state current ($T_c \leq 75^\circ\text{C}$)	$I_{T(RMS)}$	20	A
Non repetitive surge peak on-state current (full cycle , $t_p=20\text{ms}$, $T_j=25^\circ\text{C}$)	I_{TSM}	200	A
Non repetitive surge peak on-state current (full cycle , $t_p=16.6\text{ms}$, $T_j=25^\circ\text{C}$)		220	
I^2t value for fusing ($t_p=10\text{ms}$, $T_j=25^\circ\text{C}$)	I^2t	200	A^2s
Critical rate of rise of on-state current ($I_G=2 \times I_{GT}$, $f=100\text{Hz}$, $T_j=125^\circ\text{C}$)	di/dt	100	$\text{A}/\mu\text{s}$
Peak gate current ($t_p=20\mu\text{s}$, $T_j=125^\circ\text{C}$)	I_{GM}	4	A

Average gate power dissipation ($T_j=125^\circ\text{C}$)	$P_{G(AV)}$	0.5	W
Peak gate power	P_{GM}	10	W
Peak pulse voltage ($T_j=25^\circ\text{C}$; non-repetitive, off-state; FIG.7)	V_{pp}	4	kV

ELECTRICAL CHARACTERISTICS ($T_j=25^\circ\text{C}$ unless otherwise specified)

Symbol	Test Condition	Quadrant	Value		Unit
I_{GT}	$V_D=12\text{V } R_L=33\Omega$	I - II -III	MAX.	35	mA
V_{GT}		I - II -III	MAX.	1	V
V_{GD}	$V_D=V_{DRM} T_j=125^\circ\text{C}$ $R_L=3.3\text{k}\Omega$	I - II -III	MIN.	0.2	V
I_L	$I_G=1.2I_{GT}$	I -III	MAX.	50	mA
		II		60	
I_H	$I_T=500\text{mA}$		MAX.	40	mA
dV/dt	$V_D=400\text{V}$ Gate Open $T_j=125^\circ\text{C}$		MIN.	2000	V/ μs
(dI/dt) _c	(dV/dt) _c =20V/ μs $T_j=125^\circ\text{C}$		MIN.	20	A/ms
t_{on}	$I_G=40\text{mA } I_A=200\text{mA } I_R=20\text{mA}$ $T_j=25^\circ\text{C}$		TYP.	7	μs
t_{off}				50	

STATIC CHARACTERISTICS

Symbol	Parameter		Value(MAX.)	Unit
V_{TM}	$I_{TM}=28\text{A } t_p=380\mu\text{s}$	$T_j=25^\circ\text{C}$	1.4	V
V_{TO}	Threshold voltage	$T_j=125^\circ\text{C}$	0.75	V
R_D	Dynamic resistance	$T_j=125^\circ\text{C}$	20	m Ω
I_{DRM}	$V_D=V_{DRM} V_R=V_{RRM}$	$T_j=25^\circ\text{C}$	5	μA
I_{RRM}		$T_j=125^\circ\text{C}$	0.8	mA

THERMAL RESISTANCES

Symbol	Parameter	Value	Unit
$R_{th(j-c)}$	junction to case (AC)	1.9	$^\circ\text{C/W}$
$R_{th(j-a)}$	junction to ambient (AC)	60	$^\circ\text{C/W}$

ORDERING INFORMATION

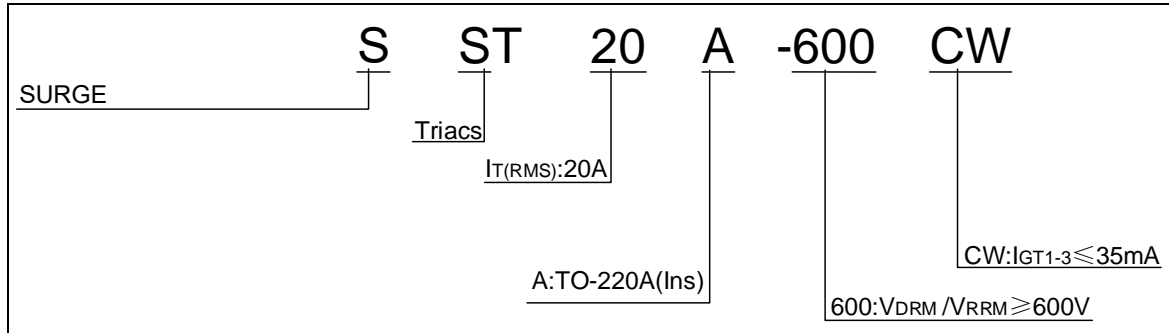

MARKING

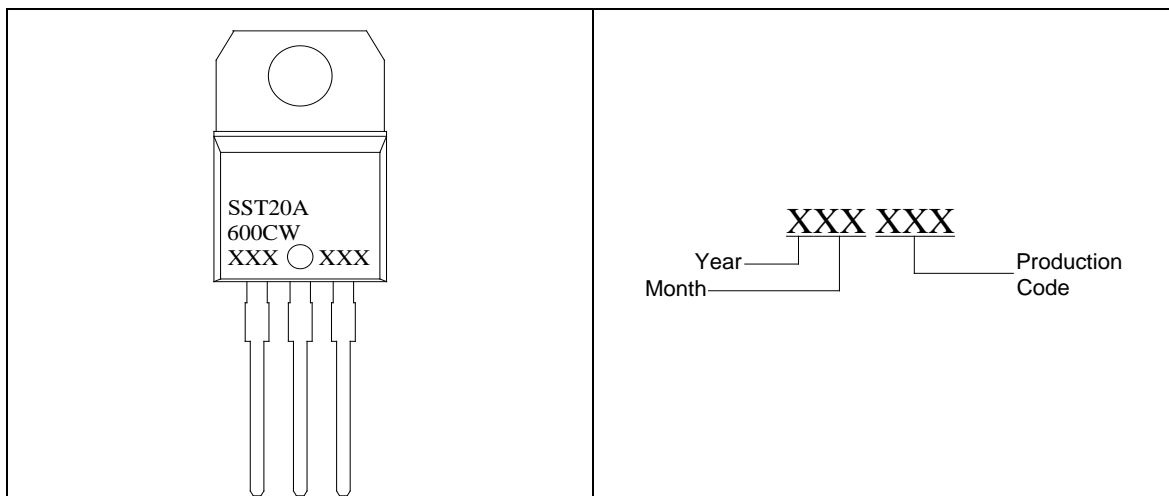

FIG.1: Maximum power dissipation versus RMS on-state current

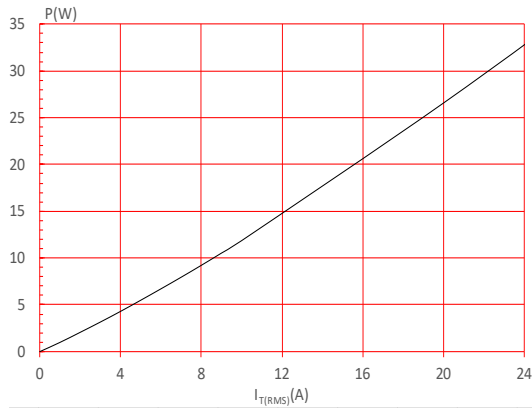

FIG.2: RMS on-state current versus case temperature

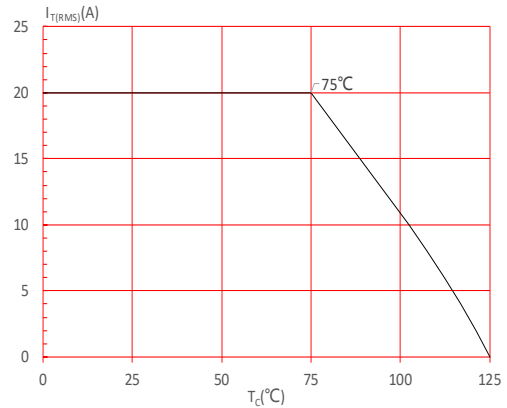

FIG.3: Surge peak on-state current versus number of cycles

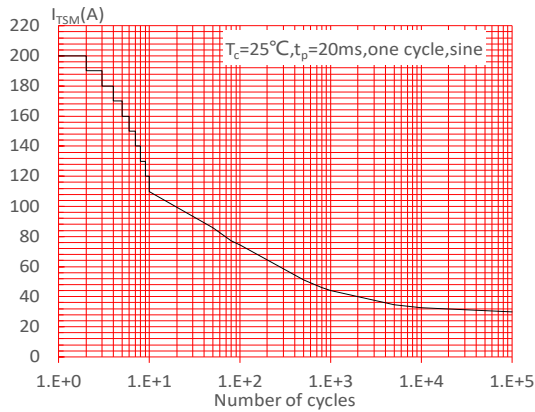

FIG.4: On-state characteristics

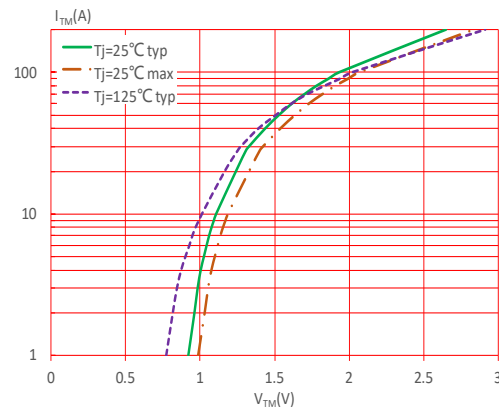

FIG.5: Non-repetitive surge peak on-state current for a sinusoidal pulse with width $t_p < 20\text{ms}$, and corresponding value of I^2t ($di/dt < 100\text{A}/\mu\text{s}$)

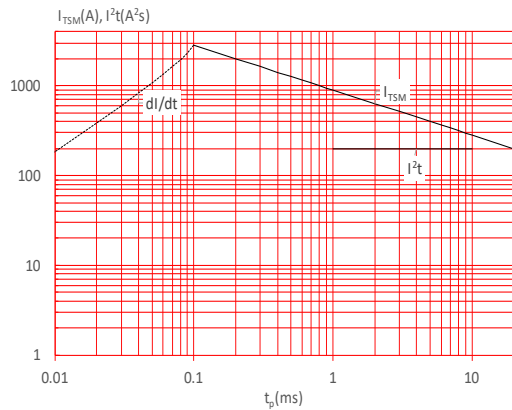

FIG.6: Relative variations of gate trigger current, holding current and latching current versus junction temperature

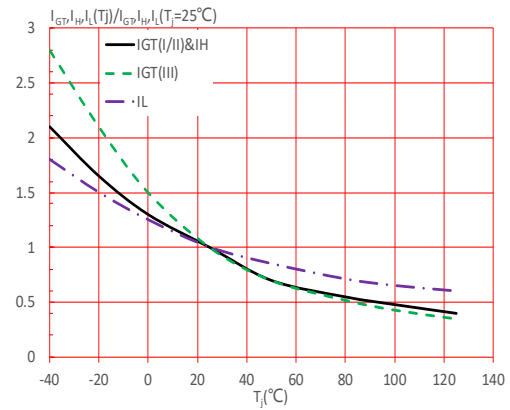
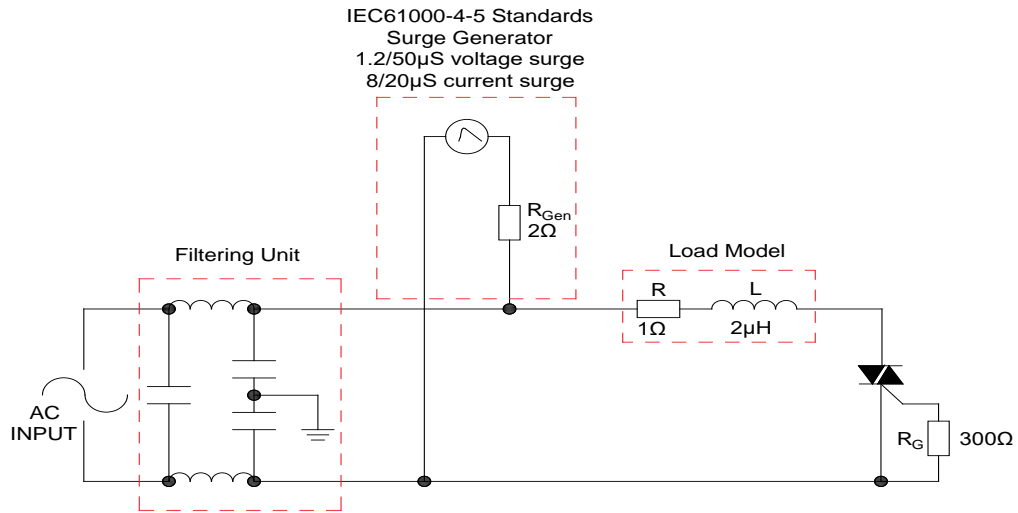

FIG.7: Test circuit for inductive and resistive loads to IEC-61000-4-5 standards



LEAD FORMING AND SOLDERING

Refer to the application note “Assembly Instructions for Thyristors in Through-hole Package”

ORDERING INFORMATION

Order code	Voltage V_{DRM}/V_{RRM} (V)	IGT(mA)	Package	Base qty. (pcs)	Delivery mode
		I - II - III			
SST20A-600CW	600	35	TO-220A(Ins)	50	Tube

Document Revision History

Date	Revision	Changes
Apr.12, 2023	A.1.0	Last updated
Oct.13, 2025	A.1.1	Revise PACKAGE MECHANICAL DATA

PACKAGE MECHANICAL DATA

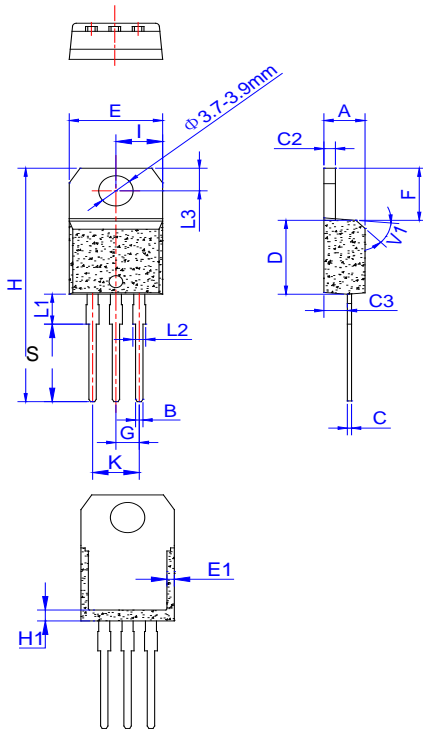

Ref.	Dimensions					
	Millimeters			Inches		
	Min.	Typ.	Max.	Min.	Typ.	Max.
A	4.40		4.60	0.173		0.181
B	0.61		0.88	0.024		0.035
C	0.46		0.70	0.018		0.028
C2	1.21		1.32	0.048		0.052
C3	2.40		2.72	0.094		0.107
D	8.60		9.70	0.339		0.382
E	9.80		10.40	0.386		0.409
E1	1.00		1.40	0.039		0.055
F	6.25		6.85	0.246		0.270
G	2.40		2.70	0.094		0.106
H	28.00		29.80	1.102		1.173
H1	1.80		2.20	0.071		0.087
I	4.80		5.20	0.189		0.205
S	9.55		9.95	0.376		0.392
K	4.80		5.20	0.189		0.205
L1	3.45		4.05	0.136		0.159
L2	1.14		1.70	0.045		0.067
L3	2.65		2.95	0.104		0.116
V1		45°			45°	

DELIVERY MODE

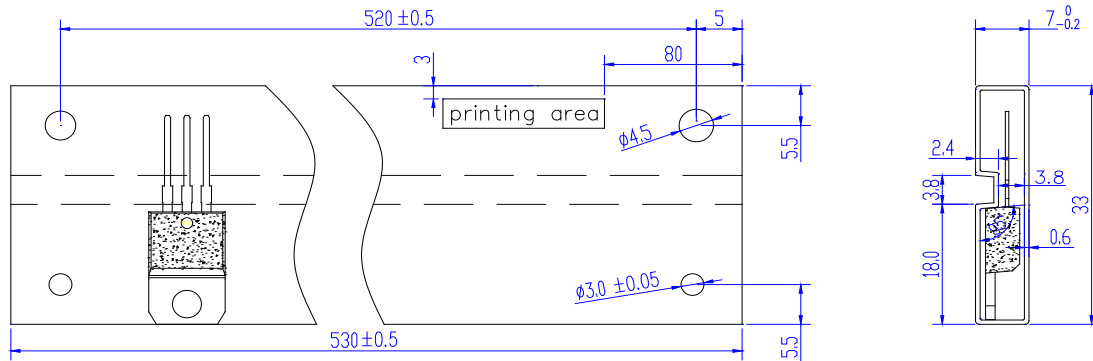

PACKAGE	OUTLINE	TUBE (PCS)	INNER BOX (PCS)	PER CARTON
TO-220A	TUBE	50	1,000	5,000

Information furnished in this document is believed to be accurate and reliable. However, Surge Components assumes no responsibility for the consequences of use without consideration for such information nor use beyond it. Information mentioned in this document is subject to change without notice.

Products and information provided in this document have no infringement of patents. Surge Components assumes no responsibility for any infringement of other rights of third parties which may result from the use of such products and information. This document supersedes and replaces all information previously supplied.