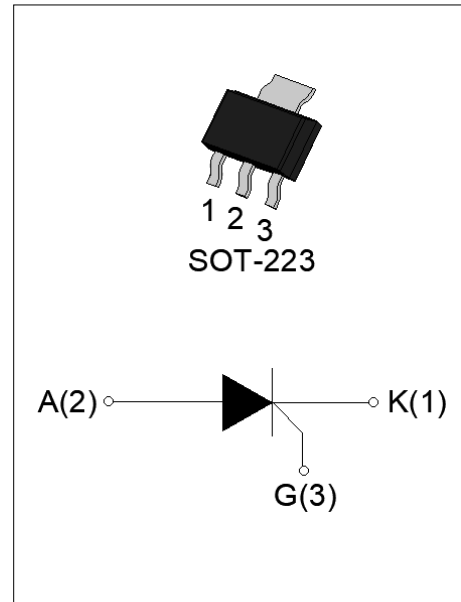


DESCRIPTION:

The SX020V SCR provides high dV/dt rate with strong resistance to electromagnetic interface. It is especially recommended for use on residual current circuit breaker, straight hair, igniter etc. Package SOT-223 is RoHS compliant.

MAIN FEATURES

Symbol	Value	Unit
$I_{T(RMS)}$	2	A
V_{DRM} / V_{RRM}	600	V
I_{GT}	≤ 200	μA


ABSOLUTE MAXIMUM RATINGS

Parameter	Symbol	Value	Unit
Storage junction temperature range	T_{stg}	-40-150	$^{\circ}C$
Operating junction temperature range	T_j	-40-125 ^①	$^{\circ}C$
Repetitive peak off-state voltage ($T_j=25^{\circ}C$)	V_{DRM}	600	V
Repetitive peak reverse voltage ($T_j=25^{\circ}C$)	V_{RRM}	600	V
Average on-state current ($T_c \leq 72^{\circ}C$)	$I_{T(AV)}$	1.3	A
RMS on-state current ($T_c \leq 72^{\circ}C$)	$I_{T(RMS)}$	2	A
Non repetitive surge peak on-state current ($t_p=10ms, T_j=25^{\circ}C$)	I_{TSM}	20	A
Non repetitive surge peak on-state current ($t_p=8.3ms, T_j=25^{\circ}C$)		22	
I^2t value for fusing ($t_p=10ms, T_j=25^{\circ}C$)	I^2t	2	A^2s
Critical rate of rise of on-state current ($I_G=2 \times I_{GT}, f=100Hz, T_j=125^{\circ}C$)	di/dt	50	$A/\mu s$
Peak gate current ($t_p=20\mu s, T_j=125^{\circ}C$)	I_{GM}	1.2	A
Average gate power dissipation ($T_j=125^{\circ}C$)	$P_{G(AV)}$	0.2	W

Peak gate power	P_{GM}	2	W
Peak pulse voltage ($T_j=25^\circ\text{C}$; non-repetitive, off-state; FIG.8)	V_{pp}	0.5	kV

NOTE 1: Operating junction temperature T_j is up to 125°C when a resistor $\leq 1\text{k}\Omega$ is connected between Gate and Cathode. Without this resistor, the T_j is up to 110°C only.

ELECTRICAL CHARACTERISTICS ($T_j=25^\circ\text{C}$ unless otherwise specified)

Symbol	Test Condition	Value			Unit
		MIN.	TYP.	MAX.	
I_{GT}	$V_D=12\text{V}$ $R_L=33\Omega$	-	50	200	μA
V_{GT}		-	0.6	0.8	V
V_{GD}	$V_D=V_{DRM}$ $T_j=125^\circ\text{C}$	0.2	-	-	V
I_L	$I_G=1.2 I_{GT}$	-	-	6	mA
I_H	$I_T=0.05\text{A}$	-	-	5	mA
dV/dt	$V_D=400\text{V}$ $T_j=125^\circ\text{C}$ $R_{GK}=1\text{k}\Omega$	20	-	-	V/ μs
	$V_D=400\text{V}$ $T_j=125^\circ\text{C}$ $R_{GK}=220\Omega$	100	-	-	
t_{on}	$I_G=10\text{mA}$ $I_A=20\text{mA}$ $I_R=2\text{mA}$ $T_j=25^\circ\text{C}$	-	2	-	μs
t_{off}		-	50	-	μs

STATIC CHARACTERISTICS

Symbol	Parameter		Value(MAX.)	Unit
V_{TM}	$I_T=4\text{A}$ $t_p=380\mu\text{s}$	$T_j=25^\circ\text{C}$	1.5	V
V_{TO}	Threshold voltage	$T_j=125^\circ\text{C}$	0.8	V
R_D	Dynamic Resistance	$T_j=125^\circ\text{C}$	0.07	Ω
I_{DRM}	$V_D=V_{DRM}$ $V_R=V_{RRM}$	$T_j=25^\circ\text{C}$	5	μA
I_{RRM}		$T_j=125^\circ\text{C}$	0.2	mA

THERMAL RESISTANCES

Symbol	Parameter	Value	Unit
$R_{th(j-c)}$	junction to case (DC)	20	$^\circ\text{C/W}$
$R_{th(j-a)}$	junction to ambient (DC)	130	$^\circ\text{C/W}$

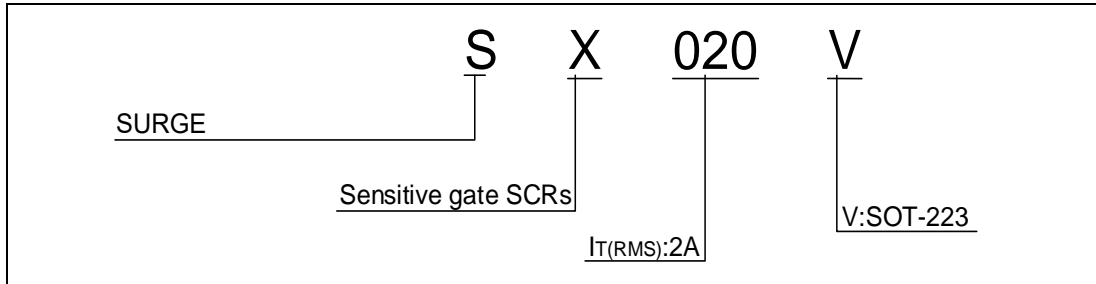
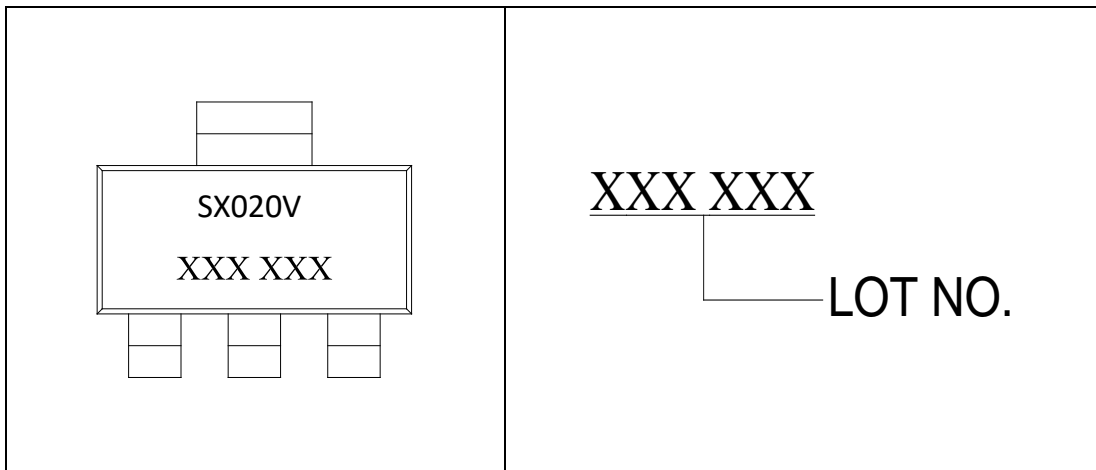
ORDERING INFORMATION

MARKING


FIG.1: Maximum power dissipation versus RMS on-state current

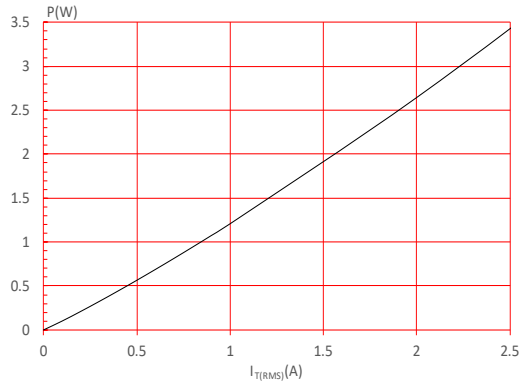


FIG.2: RMS on-state current versus case temperature

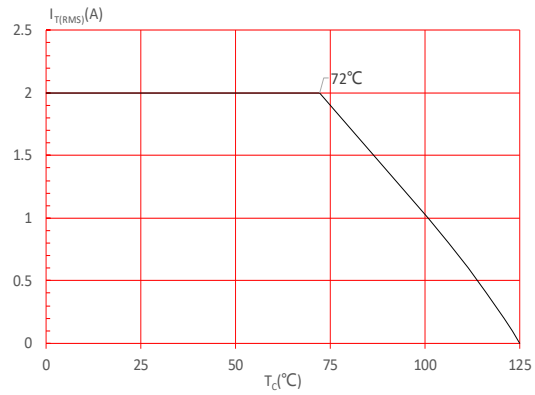


FIG.3: RMS on-state current versus ambient temperature (printed circuit board FR4,copper thickness:35µm)(full cycle)

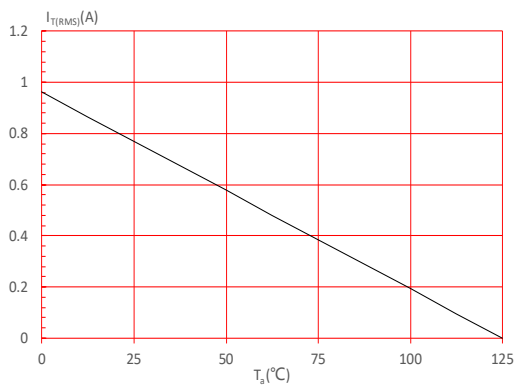


FIG.4: Surge peak on-state current versus number of cycles

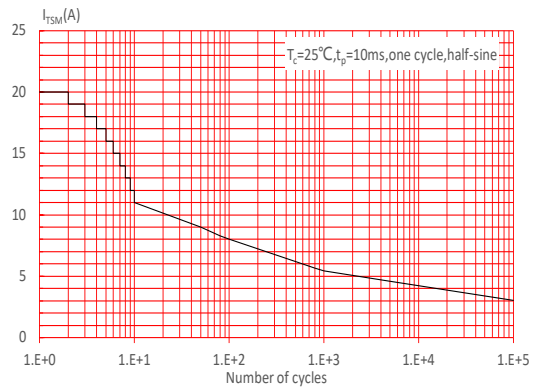


FIG.5: On-state characteristics

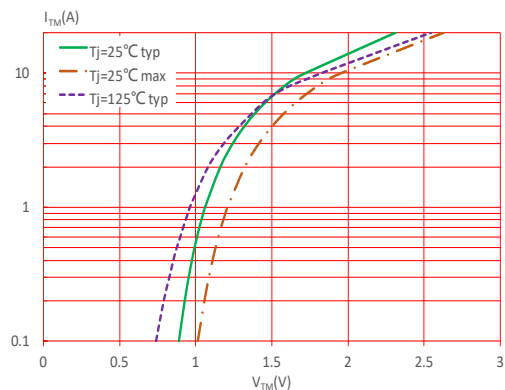


FIG.6: Non-repetitive surge peak on-state current for a sinusoidal pulse with width $t_p < 10\text{ms}$, and corresponding value of I^2t ($di/dt < 50\text{A}/\mu\text{s}$)

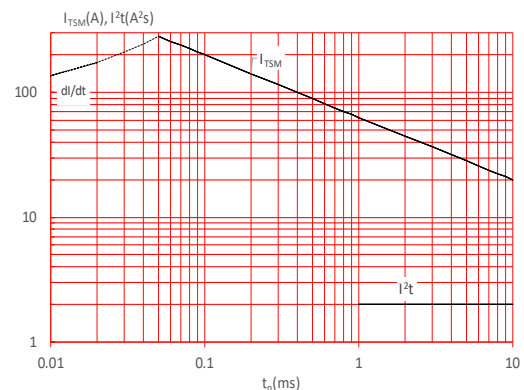


FIG.7: Relative variations of gate trigger current, holding current and latching current versus junction temperature

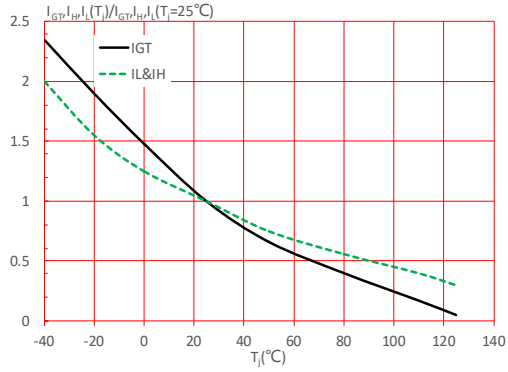
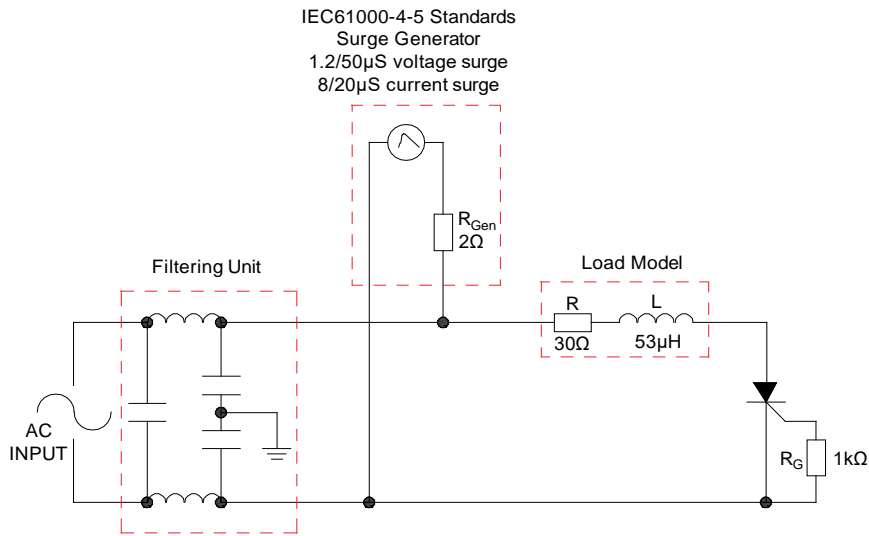
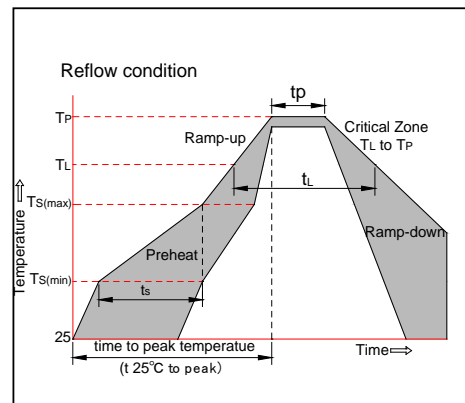


FIG.8: Test circuit for inductive and resistive loads to IEC-61000-4-5 standards.

SOLDERING PARAMETERS

Reflow Condition		Pb-Free assembly (see figure at right)
Pre Heat	-Temperature Min ($T_{s(min)}$)	+150°C
	-Temperature Max ($T_{s(max)}$)	+200°C
	-Time (Min to Max) (t_s)	60-180 secs.
Average ramp up rate (Liquidus Temp (T_L) to peak)		3°C/sec. Max
$T_{s(max)}$ to T_L - Ramp-up Rate		3°C/sec. Max
Reflow	-Temperature(T_L) (Liquidus)	+217°C
	-Temperature(t_L)	60-150 secs.
Peak Temp (T_p)		+260(+0/-5)°C
Time within 5°C of actual Peak Temp (t_p)		20-40secs.
Ramp-down Rate		6°C/sec. Max
Time 25°C to Peak Temp (T_p)		8 min. Max
Do not exceed		+260°C

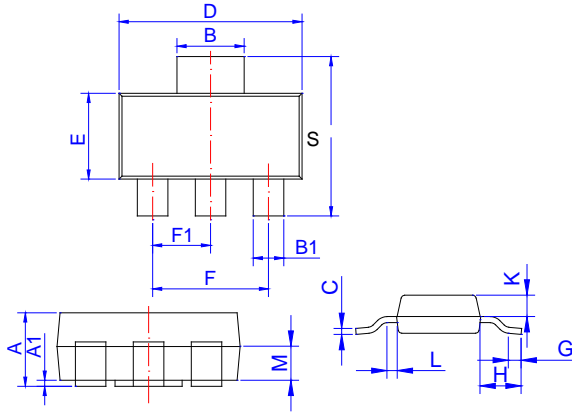


ORDERING INFORMATION

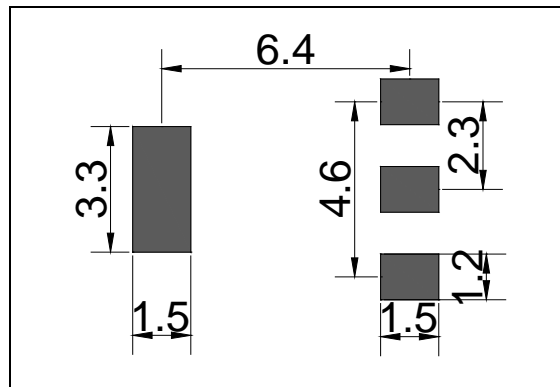
Order code	Voltage V_{DRM}/V_{RRM} (V)	IGT(μ A)	Package	Base qty. (pcs)	Delivery mode
SX020V	600	≤ 200	SOT-223	4,000	Tape & Reel

Document Revision History

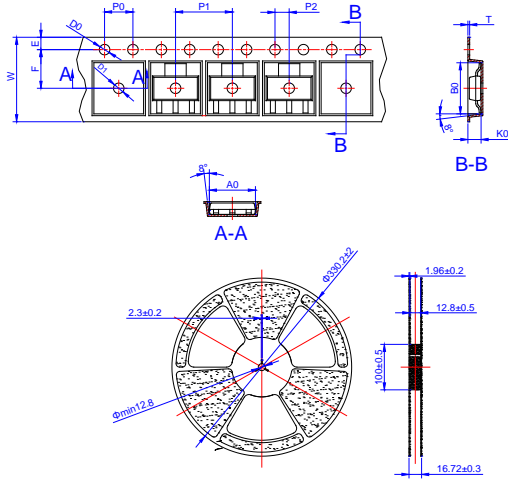
Date	Revision	Changes
Apr.12, 2023	A.1.0	Last update
Oct.23, 2025	A.1.1	Revise PACKAGE MECHANICAL DATA

PACKAGE MECHANICAL DATA


Ref.	Dimensions					
	Millimeters			Inches		
	Min.	Typ.	Max.	Min.	Typ.	Max.
A	1.50	1.60	1.80	0.059	0.063	0.071
A1	0.01	0.06	0.10	0.001	0.002	0.004
B	2.90	3.00	3.10	0.114	0.118	0.122
B1	0.60	0.70	0.80	0.024	0.028	0.031
C	0.22	0.26	0.32	0.009	0.010	0.013
D	6.30	6.50	6.70	0.248	0.256	0.264
E	3.30	3.50	3.70	0.130	0.138	0.146
F	4.40		4.80	0.173		0.189
F1	2.20		2.40	0.087		0.094
G	0.50		1.00	0.020		0.039
H	1.50	1.75	2.00	0.059	0.069	0.079
S	6.70	7.00	7.30	0.264	0.276	0.287
K	0.80		1.00	0.031		0.039
L	0.40		0.80	0.016		0.031
M	0.75		0.95	0.030		0.037

FOOTPRINT-SOT-223 (dimensions in mm)


DELIVERY MODE



Ref.	Dimensions					
	Millimeters			Inches		
	Min.	Typ.	Max.	Min.	Typ.	Max.
W	-	-	12.30	-	-	0.482
E	1.65	1.75	1.85	0.065	0.069	0.073
F	5.45	5.50	5.55	0.215	0.217	0.219
D0	1.50	1.55	1.60	0.059	0.061	0.063
D1	1.50	-	-	0.059	-	-
P0	3.90	4.00	4.10	0.154	0.157	0.161
P1	7.90	8.00	8.10	0.311	0.315	0.319
P2	1.95	2.00	2.05	0.077	0.079	0.081
10P0	39.80	40.00	40.20	1.567	1.575	1.583
A0	6.85	6.95	7.05	0.269	0.273	0.276
B0	7.15	7.25	7.35	0.280	0.284	0.288
K0	1.95	2.05	2.15	0.076	0.080	0.084
T	0.20	0.25	0.30	0.008	0.010	0.012

PACKAGE	OUTLINE	REEL (PCS)	PER CARTON (PCS)	TAPE & REEL
SOT-223	TAPING	4,000	40,000	13 inch

Information furnished in this document is believed to be accurate and reliable. However, Surge Components assumes no responsibility for the consequences of use without consideration for such information nor use beyond it. Information mentioned in this document is subject to change without notice.

Products and information provided in this document have no infringement of patents. Surge Components assumes no responsibility for any infringement of other rights of third parties which may result from the use of such products and information. This document supersedes and replaces all information previously supplied.